

B O R N T O B E M O T O



 **LightTech**

italian racing components

USA & Canada Distributor:



2013

## **USA Distributor**

OPP Racing  
1927 Boblett Street  
Blaine, WA, USA  
98230



## **Canada Distributor**

OPP Racing  
#101B 1952 Kingsway Ave  
Port Coquitlam, BC, Canada  
V3C 6C2

Website: [www.oppracing.com](http://www.oppracing.com)

Email: [info@oppracing.com](mailto:info@oppracing.com)

Ph# 1-877-942-6744 (toll-free in N. America)

Ph# 1-604-942-6744 (International & BC)

Fax# 1-604-942-6745

**OPP Racing is a performance motorcycle parts distributor, with stocking warehouses in WA, USA and BC, Canada. OPP Racing is responsible for stocking and promoting LighTech products within USA & Canada, as well as facilitating dealer incentive programs and sponsorship opportunities.**

**OPP Racing And LighTech are proud to have a long history together in making premium Italian racing components available to the North American market.**



## listinoprezzi | pricelist

### **PEDANE** | REAR SETS

regolabili - adjustable .....	pag. 12
componenti ricambio - spare parts .....	pag. 21

### **TENDITORI CATENA** | CHAIN ADJUSTERS

tenditori catena - chain adjusters .....	pag. 26
supporti cavalletto - swing arm spools .....	pag. 28

### **LEVE** | LEVERS

leve freno - brake levers .....	pag. 30
leve frizioni - clutch levers .....	pag. 34
KIT leve - KIT levers .....	pag. 36
ricambi leve - levers spare parts .....	pag. 38
mozzetti e tubi - Handlebar holders and handlebar tubes .....	pag. 39

### **ACCESSORI MANUBRIO** | HANDLEBAR ACCESSORIES

contrappesi manubrio - handle bar balancers .....	pag. 42
regolatori molla forcella - fork spring adjusters .....	pag. 44

### **SPECCHI** | MIRRORS

specchi in carbonio - carbon mirrors .....	pag. 46
in alluminio - aluminium mirrors .....	pag. 48
tappo specchio - mirror block-off plates .....	pag. 49

### **PORTA TARGA** | LICENSE PLATE BRACKETS

regolabili - adjustable .....	pag. 52
KIT porta targa - license plate brackets KIT .....	pag. 55
luci - lights .....	pag. 57

### **PROTEZIONE** | PROTECTIONS

protezione telaio - frame sliders .....	pag. 60
ricambi protezioni telaio - Frame slider spare parts .....	pag. 62
protezioni perni ruota - wheel axle sliders .....	pag. 63
tappi telaio - frames caps .....	pag. 63

### **VITERIA** | SCREWS

ergal 7075 .....	pag. 66
titanio - titanium .....	pag. 68
special ergal 7075 - 7075 ergal special .....	pag. 70
forate - drilled .....	pag. 72
autofilettanti ergal 7075 - ergal7075 self tapping screws .....	pag. 72
ganci rapidi e ricettacoli - quick fairing and receptacle .....	pag. 72
dadi - nuts .....	pag. 74
rondelle - washers .....	pag. 75
viti dischi freno in titanio - screws for brake disk in titanium .....	pag. 76

**KIT VITI | SCREWS KIT**

kit viti - screws kit .....	pag. 78
starter kit - starter kit .....	pag. 84

**DADI SPECIAL | SPECIAL NUTS**

dadi special - special nuts .....	pag. 86
-----------------------------------	---------

**TAPPI | CAPS**

tappi serbatoio - fuel tank caps .....	pag. 90
tappi olio - oil filter caps .....	pag. 92
coperci pompe freno e frizione - clutch/brake pump reservoir covers .....	pag. 94

**R 1200 GS**

R 1200 GS .....	pag. 98
-----------------	---------

**T-MAX**

T-MAX .....	pag. 102
-------------	----------

**COMPONENTI IN CARBONIO | CARBON PARTS**

componenti in carbonio - carbons parts .....	pag. 108
--	----------

**CAVALLETTI | STANDS****RACING & BOX**

cavalletti - stands .....	pag. 118
accessori box - box accessories .....	pag. 122
saponette - knee sliders .....	pag. 124
serbatoio rifornimento rapido - fast fuel canister .....	pag. 126

**RACCORDERIA FRENO | BRAKE PARTS**

raccorderia freno - brake parts .....	pag. 128
---------------------------------------	----------

**COMUNICAZIONE | COMMUNICATION**

Comunicazione / Communication .....	pag. 130
-------------------------------------	----------

**PHOTO GALLERY | PHOTO GALLERY**

Photo Gallery / Photo Gallery .....	pag. 131
-------------------------------------	----------



## LIGHTTECH

### italianracingcomponents

Nel 1997, Fabrizio Furlan crea Lighttech per portare le competenze produttive della sua famiglia e della sua professione di pilota nell'eccitante mondo delle moto da corsa. Collaborare con prestigiosi team nel Campionato Mondiale Superbike, Moto GP, Moto 2GP e 125 GP ha permesso a Lighttech di sviluppare e diventare leader nel campo degli accessori per moto. Oggi, Lighttech si sviluppa su una superficie di 2.500 metri quadrati, così suddivisi: 1.400 dedicati alla produzione con sofisticati torni e frese a controllo numerico (CNC), 600 all'area magazzino e stoccaggio, 50 al dipartimento Ricerca e Sviluppo in cui gli ingegneri utilizzano programmi di disegno tecnico (CAD) e produzione (CAM) assistiti da computer per progettare. Oltre alla sede principale, Lighttech dispone di un altro stabilimento di 1.600 metri quadrati dotato di impianti per la produzione di pedane, leve freno-frizione e portatarga.

Il catalogo Lighttech contiene più di 7.000 prodotti in Ergal che sono realizzati in diverse colorazioni, 400 prodotti in titanio ed una serie di numerosi altri accessori. Lighttech può contare su di una rete vendita strutturata attualmente in oltre 1.500 rivenditori autorizzati in Italia e distributori in 20 altri paesi. Tale rete è in continuo ampliamento.

Lighttech è certificata UNI EN ISO/9001





## LIGHTECH italianracingcomponents



In 1997, Fabrizio Furlan created LighTech to bring his family's manufacturing expertise to the exciting world of motorcycle racing. Working closely with elite teams in the World Superbike Championship, Moto GP, 125 GP and Moto 2GP has allowed LighTech to become a leader of technologically advanced motorcycle performance parts and accessories. Today, the LighTech factory houses 2,500 square meters of which 1,400 dedicated to production with sophisticated computer-numeric-control (CNC) machines, 600 to storage area and 50 to research and development department where engineers use state-of-the-art computer-assisted design (CAD) and computer-assisted manufacturing (CAM) programs. In addition to the main factory, LighTech has a subsidiary with a 1,600 square meter facility for producing rearsets, brake and clutch levers and license plate brackets. And of course,

The scope of LighTech is enormous. The LighTech catalog contains over 7,000 ergal products that are manufactured in seven different colours, over 400 titanium products and a host of other accessories. LighTech has more than 1,500 authorized dealers in Italy and distributors in 20 countries.

LighTech is UNI EN ISO/9001



# IN PISTA CON LIGHTTECH

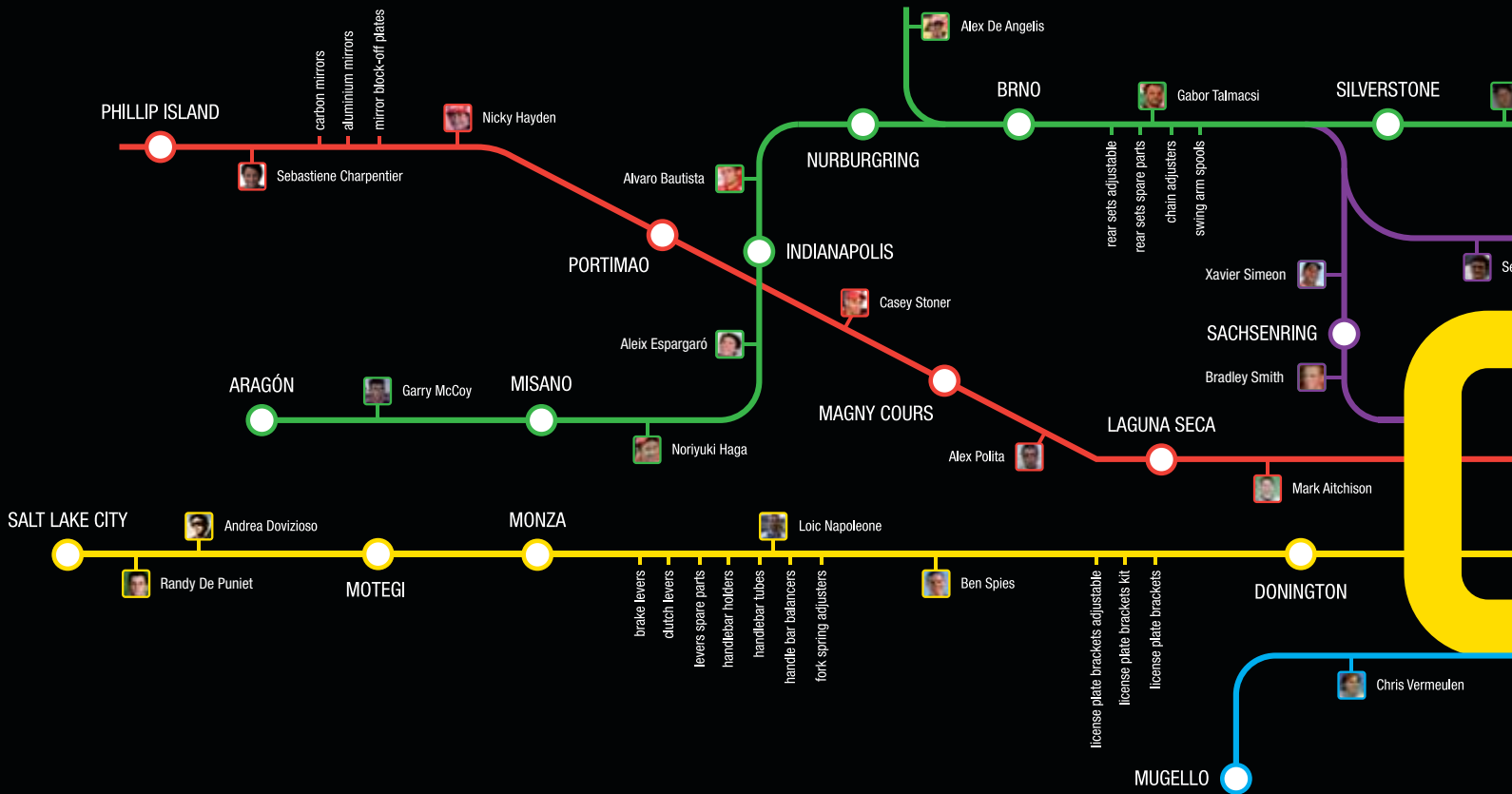

# LIGHT TECH MAP

Anni di sponsorizzazioni tecniche, l'utilizzo di un design e metodi di produzione all'avanguardia, e la passione per la moto da corsa, sono le ragioni per cui si trovano qualità e innovazione in ogni prodotto Lighttech.

Years of technical sponsorship, the use of cutting edge design and production methods and a passion for motorcycle racing are the reasons why you will find quality and innovation in every LightTech product. You can definitely believe that.





# THE RACE OF LIGHTTECH



## 2012 TECHNICAL SPONSOR

- Yamaha Factory Racing · MotoGP  
Jorge Lorenzo | Ben Spies
- Monster Yamaha Tech 3 · MotoGP  
Andrea Dovizioso | Cal Crutchlow
- JIR · Moto2  
Johann Zarco | Eric Granado
- Tech 3 B · Moto2  
Xavier Simeon | Bradley Smith

- Iodaracing · Moto GP  
Danilo Carlo Petrucci
- Iodaracing · Moto 2  
Luigi Morciano
- Iodaracing · Moto 3  
Luigi Morciano
- Aspar Team · Moto GP  
Randy De Puniet | Aleix Espargaró

- Aspar Team · Moto 2  
Jordi Torres | Nico Terol
- Aspar Team · Moto 3  
Jonas Folger | Luca Amato
- Liberty Racing · Sbk  
Jakub Smrž | Sylvain Guintoli  
Maxime Berger | Brett McCormick



DUCATI

Panigale

LightTech



**PEDANE**  
REAR SETS



## Pedane regolabili

Adjustable rear sets



KBA 90967

APRILIA



modello model	anno years	cambio rovesciato reverse shifting	codice code	€
<b>poggiapiede fisso / fixed footpeg</b>				
RSV4 R / FACTORY* / APRC*	09-12	OK	FTRAP001	
TUONO V4	11-12	OK	FTRAP001	
<b>poggiapiede snodato / fold up footpeg</b>				
RSV4 R / FACTORY* / APRC*	09-12	OK	FTRAP001W	
TUONO V4	11-12	OK	FTRAP001W	

\* Versione con cambio elettronico necessita sostituzione cella di carico / For electronic quickshifter version is necessary to change the pressure sensor

BMW



modello model	anno years	cambio rovesciato reverse shifting	codice code	€
<b>poggiapiede fisso / fixed footpeg</b>				
S1000RR	09-12	NO	FTRBM001	
S1000RR	09-12	OK	FTRBM002	
<b>poggiapiede snodato / fold up footpeg</b>				
S1000RR	09-12	NO	FTRBM001W	
S1000RR	09-12	OK	FTRBM002W	

DUCATI



modello model	anno years	cambio rovesciato reverse shifting	codice code	€
<b>poggiapiede fisso / fixed footpeg</b>				
749 / 999	02-06	OK	FTR02D999	
<b>poggiapiede snodato / fold up footpeg</b>				
749 / 999	02-06	OK	FTR02D999W	

DUCATI



modello model	anno years	cambio rovesciato reverse shifting	codice code	€
<b>poggiapiede fisso / fixed footpeg</b>				
848 / 1098 / 1198 replica SBK	07-11	OK	FTRDU005	
<b>poggiapiede snodato / fold up footpeg</b>				
848 / 1098 / 1198 replica SBK	07-11	OK	FTRDU005W	



## Pedane regolabili

### Adjustable rear sets

DUCATI



modello model	anno years	cambio rovesciato reverse shifting	codice code	€
<b>poggiapiEDE fisso / fixed footpeg</b>				
STREET FIGHTER 848 / 1100	09-12	OK	FTRDU002	

<b>poggiapiEDE snodato / fold up footpeg</b>				
STREET FIGHTER 848 / 1100	09-12	OK	FTRDU002W	

DUCATI



modello model	anno years	cambio rovesciato reverse shifting	codice code	€
<b>poggiapiEDE snodato / fold up footpeg</b>				
DIAVEL*	11-12	NO	FTRDU003W	

\* Supporto scarico disponibile in rosso o nero / Exhaust holder available in red or black color



DUCATI



modello model	anno years	cambio rovesciato reverse shifting	codice code	€
<b>poggiapiEDE fisso / fixed footpeg</b>				
PANIGALE 1199	12-12	NO	FTRDU004	
PANIGALE 1199	12-12	OK	FTRDU006	

<b>poggiapiEDE snodato / fold up footpeg</b>				
PANIGALE 1199	12-12	NO	FTRDU004W	
PANIGALE 1199	12-12	OK	FTRDU006W	

HONDA



modello model	anno years	cambio rovesciato reverse shifting	codice code	€
<b>poggiapiEDE fisso / fixed footpeg</b>				
CBR 250 R	11-12	OK	FTRHO004	

<b>poggiapiEDE snodato / fold up footpeg</b>				
CBR 250 R	11-12	OK	FTRHO004W	

## Pedane regolabili

Adjustable rear sets



KBA 90967

HONDA



modello model	anno years	cambio rovesciato reverse shifting	codice code	€
<b>poggiapiede fisso / fixed footpeg</b>				
CBR 600 RR	03-06	OK	FTR02CBR605S	
CBR 1000 RR	04-07	OK	FTR02CBR104	
<b>poggiapiede snodato / fold up footpeg</b>				
CBR 600 RR	03-06	OK	FTR02CBR605SW	
CBR 1000 RR	04-07	OK	FTR02CBR104W	

HONDA



modello model	anno years	cambio rovesciato reverse shifting	codice code	€
<b>poggiapiede fisso / fixed footpeg</b>				
CBR 600 RR	07-12	OK	FTRHO003	
<b>poggiapiede snodato / fold up footpeg</b>				
CBR 600 RR	07-12	OK	FTRHO003W	

HONDA



modello model	anno years	cambio rovesciato reverse shifting	codice code	€
<b>poggiapiede fisso / fixed footpeg</b>				
CBR 1000 RR*	08-12	OK	FTRHO002	
<b>poggiapiede snodato / fold up footpeg</b>				
CBR 1000 RR*	08-12	OK	FTRHO002W	

\*anche con ABS / also with ABS)

HONDA



modello model	anno years	cambio rovesciato reverse shifting	codice code	€
<b>poggiapiede fisso / fixed footpeg</b>				
CB 1000 R	08-12	OK	FTRHO001	
<b>poggiapiede snodato / fold up footpeg</b>				
CB 1000 R	08-12	OK	FTRHO001W	

## Pedane regolabili

### Adjustable rear sets

KAWASAKI



modello model	anno years	cambio rovesciato reverse shifting	codice code	€
<b>poggiapiiede fisso / fixed footpeg</b>				
ZX6R	05-12	OK	FTRKA004	

<b>poggiapiiede snodato / fold up footpeg</b>				
ZX6R	05-12	OK	FTRKA004W	

\* Tubo freno da rifare / Necessary to change the brake line

KAWASAKI



modello model	anno years	cambio rovesciato reverse shifting	codice code	€
<b>poggiapiiede fisso / fixed footpeg</b>				
ZX10R	08-10	OK	FTR02KZX1008	

<b>poggiapiiede snodato / fold up footpeg</b>				
ZX10R	08-10	OK	FTR02KZX1008W	

KAWASAKI



modello model	anno years	cambio rovesciato reverse shifting	codice code	€
<b>poggiapiiede fisso / fixed footpeg</b>				
ZX10R	11-12	OK	FTRKA003	

<b>poggiapiiede snodato / fold up footpeg</b>				
ZX10R	11-12	OK	FTRKA003W	

KAWASAKI



modello model	anno years	cambio rovesciato reverse shifting	codice code	€
<b>poggiapiiede fisso / fixed footpeg</b>				
Z 750	07-12	OK	FTRKA001	

<b>poggiapiiede snodato / fold up footpeg</b>				
Z 750	07-12	OK	FTRKA001W	

# Pedane regolabili

## Adjustable rear sets



KBA 90967

KAWASAKI



modello model	anno years	cambio rovesciato reverse shifting	codice code	€
<b>poggiapiede fisso / fixed footpeg</b>				
Z 1000	10-12	OK	FTRKA002	
Z 1000 SX	11-12	OK	FTRKA002	
<b>poggiapiede snodato / fold up footpeg</b>				
Z 1000	10-12	OK	FTRKA002W	
Z 1000 SX	11-12	OK	FTRKA002W	

MV



modello model	anno years	cambio rovesciato reverse shifting	codice code	€
<b>poggiapiede fisso / fixed footpeg</b>				
AGUSTA F4 / BRUTALE	00-10	OK	FTRMV001	
<b>poggiapiede snodato / fold up footpeg</b>				
AGUSTA F4 / BRUTALE	00-10	OK	FTRMV001W	

MV



modello model	anno years	cambio rovesciato reverse shifting	codice code	€
<b>poggiapiede fisso / fixed footpeg</b>				
AGUSTA F3 675	12-12	OK	FTRMV002	
<b>poggiapiede snodato / fold up footpeg</b>				
AGUSTA F3 675	12-12	OK	FTRMV002W	

SUZUKI



modello model	anno years	cambio rovesciato reverse shifting	codice code	€
<b>poggiapiede fisso / fixed footpeg</b>				
GSXR 600 / 750	06-10	OK	FTR02GSXR606	
<b>poggiapiede snodato / fold up footpeg</b>				
GSXR 600 / 750	06-10	OK	FTR02GSXR606W	



## Pedane regolabili

### Adjustable rear sets

SUZUKI



modello model	anno years	cambio rovesciato reverse shifting	codice code	€
<b>poggiapiEDE fisso / fixed footpeg</b>				
GSXR 600 / 750	11-12	OK	FTRSU002	
<b>poggiapiEDE snodato / fold up footpeg</b>				
GSXR 600 / 750	11-12	OK	FTRSU002W	

SUZUKI



modello model	anno years	cambio rovesciato reverse shifting	codice code	€
<b>poggiapiEDE fisso / fixed footpeg</b>				
GSXR 1000	05-06	OK	FTR02GSXR105	
<b>poggiapiEDE snodato / fold up footpeg</b>				
GSXR 1000	05-06	OK	FTR02GSXR105W	

SUZUKI



modello model	anno years	cambio rovesciato reverse shifting	codice code	€
<b>poggiapiEDE fisso / fixed footpeg</b>				
GSXR 1000	07-08	OK	FTR02GSXR107	
<b>poggiapiEDE snodato / fold up footpeg</b>				
GSXR 1000	07-08	OK	FTR02GSXR107W	

SUZUKI



modello model	anno years	cambio rovesciato reverse shifting	codice code	€
<b>poggiapiEDE fisso / fixed footpeg</b>				
GSXR 1000	09-12	OK	FTRSU001	
<b>poggiapiEDE snodato / fold up footpeg</b>				
GSXR 1000	09-12	OK	FTRSU001W	

## Pedane regolabili

### Adjustable rear sets



KBA 90967

TRIUMPH



modello model	anno years	cambio rovesciato reverse shifting	codice code	€
<b>poggiapiede fisso / fixed footpeg</b>				
SPEED TRIPLE 1050	05-10	NO	FTR02SPEED05	
<b>poggiapiede snodato / fold up footpeg</b>				
SPEED TRIPLE 1050	05-10	NO	FTR02SPEED05W	

TRIUMPH



modello model	anno years	cambio rovesciato reverse shifting	codice code	€
<b>poggiapiede fisso / fixed footpeg</b>				
SPEED TRIPLE 1050 / 1050 R	11-12	OK	FTRTR003	
<b>poggiapiede snodato / fold up footpeg</b>				
SPEED TRIPLE 1050 / 1050 R	11-12	OK	FTRTR003W	

TRIUMPH



modello model	anno years	cambio rovesciato reverse shifting	codice code	€
<b>poggiapiede fisso / fixed footpeg</b>				
DAYTONA 675 + 675 R	07-12	NO	FTRTR001	
STREET TRIPLE 675 + R	07-12	NO	FTRTR001	
<b>poggiapiede snodato / fold up footpeg</b>				
DAYTONA 675 + 675 R	07-12	NO	FTRTR001W	
STREET TRIPLE 675 + R	07-12	NO	FTRTR001W	

TRIUMPH



modello model	anno years	cambio rovesciato reverse shifting	codice code	€
<b>poggiapiede fisso / fixed footpeg</b>				
DAYTONA 675 + 675 R	07-12	OK	FTRTR002	
STREET TRIPLE 675 + R	07-12	OK	FTRTR002	
<b>poggiapiede snodato / fold up footpeg</b>				
DAYTONA 675 + 675 R	07-12	OK	FTRTR002W	
STREET TRIPLE 675 + R	07-12	OK	FTRTR002W	

YAMAHA



modello model	anno years	cambio rovesciato reverse shifting	codice code	€
<b>poggiapiede fisso / fixed footpeg</b>				
R6	06-07	OK	FTRYA005	
R6	08-12	OK	FTRYA002	
<b>poggiapiede snodato / fold up footpeg</b>				
R6	06-07	OK	FTRYA005W	
R6	08-12	OK	FTRYA002W	

YAMAHA



modello model	anno years	cambio rovesciato reverse shifting	codice code	€
<b>poggiapiede fisso / fixed footpeg</b>				
R1	07-08	OK	FTRYA003	
<b>poggiapiede snodato / fold up footpeg</b>				
R1	07-08	OK	FTRYA003W	

YAMAHA



modello model	anno years	cambio rovesciato reverse shifting	codice code	€
<b>poggiapiede fisso / fixed footpeg</b>				
R1	09-12	OK	FTRYA001	
<b>poggiapiede snodato / fold up footpeg</b>				
R1	09-12	OK	FTRYA001W	

YAMAHA



modello model	anno years	cambio rovesciato reverse shifting	codice code	€
<b>poggiapiede fisso / fixed footpeg</b>				
FZ1	06-12	NO	FTRYA004	
FZ8*	10-12	NO	FTRYA004	
<b>poggiapiede snodato / fold up footpeg</b>				
FZ1	06-12	NO	FTRYA004W	
FZ8*	10-12	NO	FTRYA004W	

\* Tubo freno da rifare / Necessary to change the brake line

## Pedane regolabili Limited Edition

Limited Edition Adjustable Rear Sets



KBA 90967

- 1** Viteria in titanio  
Titan screws
- 2** Poggiapiede snodato  
Fold up footpeg
- 3** Puntalino snodato  
Folding front toe peg
- 4** Cuscinetti High Quality  
High Quality Bearings

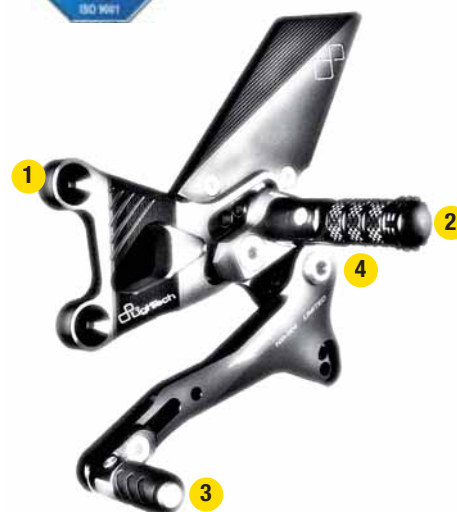

APRILIA



modello model	anno years	cambio rovesciato reverse shifting	codice code	€
<b>poggiapiede snodato / fold up footpeg</b>				
RSV4 R / FACTORY* / APRC*	09-12	OK	FTRAP001LTD	

\* Versione con cambio elettronico necessita sostituzione cella di carico / For electronic quickshifter version is necessary to change the pressure sensor

BMW



modello model	anno years	cambio rovesciato reverse shifting	codice code	€
<b>poggiapiede snodato / fold up footpeg</b>				
S1000RR	09-12	NO	FTRBM001LTD	
S1000RR	09-12	OK	FTRBM002LTD	

YAMAHA



modello model	anno years	cambio rovesciato reverse shifting	codice code	€
<b>poggiapiede snodato / fold up footpeg</b>				
R1	09-12	OK	FTRYA001LTD	



Conversion Kit - Universal

OLD version



+

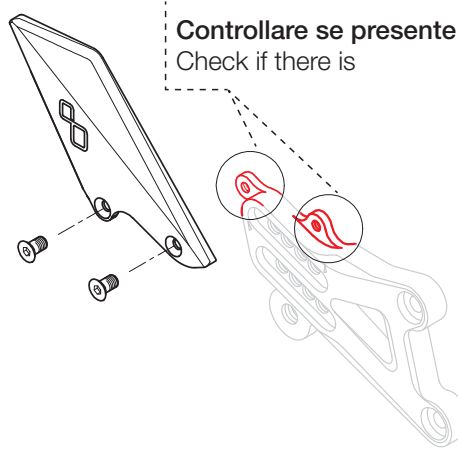

=

NEW version



codice-code: RFTR193

Kit di conversione universale  
Universal Conversion Kit



Kit conversione cambio rovesciato - Reverse shifting Conversion Kit



codice-code: RFTR164

Kit di conversione BMW  
Kit de conversion BMW









codice-code: FTR530

Leva Ducati 848 / 1098 / 1198  
Lever Ducati 848 / 1098 / 1198







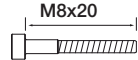

## Componenti ricambio per pedane

Rear set spare parts



Poggia piede Footpeg		Code
 +  =	M8x20	RFTR189
 +  =	M8x45	RFTR32
 +  =	M8x25	RFTR45
 +  =	M8x20	RFTR178



Poggia piede snodato Folding footpeg		Code
 +  =	M8x20	RFTR121
 +  =	M8x40	RFTR71
 +  =	M8x25	RFTR72
 +  =	M8x20	RFTR177



codice-code: RFTR52

**Puntalino**  
Front toe peg



codice-code: RFTR154

**Puntalino snodato**  
Folding front toe peg



codice-code: RFTR156

**Puntalino snodato**  
Folding front toe peg



codice-code: FTR290

**Supporto puntalino**  
Toe peg holder



codice-code: FTR469  
Magnesio - Magnesium



codice-code: FTR468  
Magnesio - Magnesium



codice-code: FTR471  
Carbonio - Carbon



codice-code: FTR470  
Carbonio - Carbon



codice-code: FTR418  
Alluminio - Aluminium



codice-code: FTR419  
Alluminio - Aluminium



Code: FTR291LTD  
Supporto poggiatele lato freno  
Footpeg holder brake side



Code: FTR507SIL  
Supporto poggiatele lato freno  
Footpeg holder brake side



Code: FTR291  
Supporto poggiatele lato freno  
Footpeg holder brake side



Code: FTR292LTD  
Supporto poggiatele lato cambio  
Footpeg holder shift side



Code: FTR508SIL  
Supporto poggiatele lato cambio  
Footpeg holder shift side



Code: FTR292  
Supporto poggiatele lato cambio  
Footpeg holder shift side

## Componenti ricambio per pedane

Rear set spare parts



codice-code: FTR 280

Alluminio - Aluminium



codice-code: FTR 282

Alluminio - Aluminium



codice-code: FTR 286

Alluminio - Aluminium



codice-code: FTR 313

Alluminio - Aluminium



codice-code: FTR 281

Carbonio - Carbon



codice-code: FTR 283

Carbonio - Carbon



Uniball

Mas M6 dx = VAR1036  
Mas M6 sx = VAR1077



Uniball

Fem M6 dx = VAR1095  
Fem M6 sx = VAR1076



codice-code: FTR236

Millerighe - Gear shift arm



codice-code: RFTR93

Interruttore stop idraulico (M10 x 1,25)  
Hydraulic stop switch (M10 x 1,25)



codice-code: RFTR128

Interruttore stop idraulico (M10 x 1)  
Hydraulic stop switch (M10 x 1)



codice-code: FTR429

Millerighe - Gear shift arm



Alluminio - Aluminium

mm 155 · cod. FTR 75  
mm 165 · cod. FTR 252  
mm 175 · cod. FTR 365  
mm 180 · cod. FTR 184  
mm 190 · cod. FTR 62  
mm 197 · cod. FTR 97  
mm 205 · cod. FTR 163  
mm 220 · cod. FTR 238  
mm 240 · cod. FTR 32



Inox - Steel

mm 165 · cod. FTR 329  
mm 175 · cod. FTR 228  
mm 190 · cod. FTR 56



# TENDICATENA CHAIN ADJUSTER



## Tenditori catena

Chain adjusters

modello - model	anno - years		codice - code	€ a coppia - for pair
	dal - from	al - to		
APRILIA RSV4 R / FACTORY / APRC	09	12	TEAP001	
APRILIA TUONO V4	11	12	TEAP001	
BMW S1000 RR	09	12	TEBM001	
HONDA CBR 600	07	12	TEHO001	
HONDA CBR 1000	06	07	TEH107	
HONDA CBR 1000	08	12	TEHO001	
KAWASAKI ZX6R	07	08	TEZX607	
KAWASAKI ZX6R	09	12	TEZX609	
KAWASAKI ZX10R	08	10	TEZX108	
KAWASAKI ZX10R	10	12	TEKA001	
SUZUKI GSXR 600 / 750	06	10	TESK7	
SUZUKI GSXR 600 / 750	11	12	TESU001	
SUZUKI GSXR 1000	07	08	TESK7	
SUZUKI GSXR 1000	09	12	TESK9	
TRIUMPH DAYTONA 675	07	11*	TET675	
TRIUMPH DAYTONA 675 / 675 R	11*	12	TETR001	
TRIUMPH STREET TRIPLE 675	07	12*	TET675	
TRIUMPH STREET TRIPLE 675 R	08	12	TETR001	
YAMAHA R6	06	12	TEY608	
YAMAHA R1	07	08	TEY107	
YAMAHA R1	09	12	TEY109	

\* Verificare compatibilità / Always check compatibility



YAMAHA R6



Colori disponibili: nero, indaco, oro, rosso. Available colours: black, indigo, gold, red.

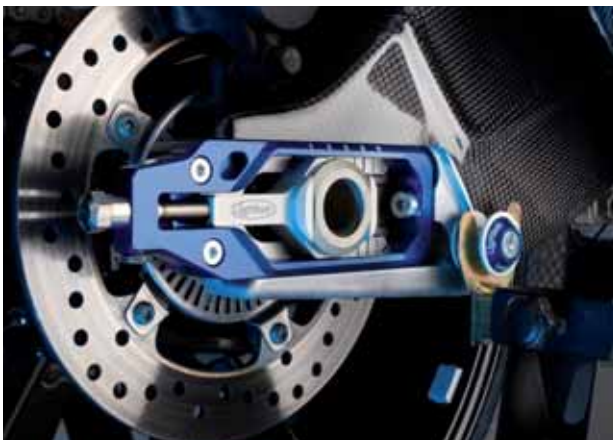



## Forchette tenditori catena

Lifters for chain adjusters

modello - model	anno - years		codice - code	€ a coppia - for pair
	dal - from	al - to		
APRILIA RSV4 R / FACTORY / APRC	09	12	FTEAP001	
APRILIA TUONO V4	11	12	FTEAP001	
BMW S 1000 RR	09	12	FTEBM001	
HONDA CBR 600	07	12	FTEH607	
HONDA CBR 1000	06	12	FTEH607	
KAWASAKI ZX6R	07	12	FTEZX607	
KAWASAKI ZX10R	08	12	FTEZX607	
SUZUKI GSXR 600/750	06	12	FTESK7	
SUZUKI GSXR 1000	07	12	FTESK7	
YAMAHA R1	07	12	FTEY107	



Colori disponibili: nero, silver.  
Available colours: black, silver.

## Supporti per cavalletti

### Swing arm spoils

misura - measure	codice - code	€
		a coppia - for pair
M6	CAVM6 (Triumph* / Yamaha* / Aprilia*)	
M8	CAVM8 (Suzuki* / Honda* / BMW*)	
M10 X 1,50	CAVM1015 (KTM*)	
M10 x 1,25	CAVM10 (Kawasaki*)	

\* Verificare compatibilità / Always check compatibility

CAVM1015 solo in silver e nero. CAVM1015 only in silver or black.

Colori disponibili: rosso, indaco, oro, blu, silver, nero.  
Available colours: red, indigo, gold, blue, silver, black.



misura - measure	codice - code	€
		a coppia - for pair
M6	CAVM6W (Triumph* / Yamaha* / Aprilia*)	
M8	CAVM8W (Suzuki* / Honda* / BMW*)	
M10 x 1,25	CAVM10W (Kawasaki*)	

\* Verificare compatibilità / Always check compatibility

Colori disponibili: rosso, indaco, oro, blu, nero.  
Available colours: red, indigo, gold, blue, black.









**LEVE  
LEVERS**

## Leve freno ribaltabile con regolazione da destra

Folding brake levers adjustable from right





Colori disponibili: nero. Available colours: black

modello - model	anno - years		codice - code <b>J</b>	€	codice - code <b>W</b>	€
	dal - from	al - to				
						
<b>BREMBO</b>						
BREMBO (16 x 18) (19 x 18)			LEVD502J		LEVD502W	
BREMBO (19 x 20)			LEVD503J		LEVD503W	
<b>APRILIA</b>						
APRILIA RSV1000	04	09	LEVD010J		LEVD010W	
APRILIA RSV4 R / factory /APRC	09	12	LEVD010J		LEVD010W	
<b>BMW</b>						
BMW S1000 RR	09	12	LEVD012J		LEVD012W	
<b>DUCATI</b>						
DUCATI 749-999	02	06	LEVD010J		LEVD010W	
DUCATI 848-1098-1198	07	12	LEVD010J		LEVD010W	
DUCATI Streetfighter 848 / 1100	09	12	LEVD010J		LEVD010W	
DUCATI Monster 1100	10	12	LEVD010J		LEVD010W	
DUCATI DIAVEL	11	12	LEVD010J		LEVD010W	
DUCATI PANIGALE 1199	12	12	LEVD010J		LEVD010W	
<b>HONDA</b>						
HONDA HORNET 600	07	10	LEVD004J		LEVD004W	
HONDA CBR 600 RR	07	12	LEVD009J		LEVD009W	
HONDA CBR 600 F	11	12	LEVD004J		LEVD004W	
HONDA CBR 1000 RR	04	12	LEVD009J		LEVD009W	
HONDA CB 1000 R	08	12	LEVD009J		LEVD009W	

## Leve freno ribaltabile con regolazione da destra

Folding brake levers adjustable from right



modello - model	anno - years		codice - code <b>J</b>	€	codice - code <b>W</b>	€
	dal - from	al - to				
						
<b>KAWASAKI</b>						
KAWASAKI ZX6R	00	04	LEVD004J		LEVD004W	
KAWASAKI ZX6R / 636	05	12	LEVD009J		LEVD009W	
KAWASAKI Z750	04	06	LEVD004J		LEVD004W	
KAWASAKI Z750	07	12	LEVD011J		LEVD011W	
KAWASAKI Z750R	11	12	LEVD009J		LEVD009W	
KAWASAKI Z1000	03	06	LEVD004J		LEVD004W	
KAWASAKI Z1000	07	12	LEVD009J		LEVD009W	
KAWASAKI Z1000 SX	11	12	LEVD009J		LEVD009W	
KAWASAKI ZX10R	04	05	LEVD004J		LEVD004W	
KAWASAKI ZX10R	06	12	LEVD009J		LEVD009W	
KAWASAKI Versys	06	12	LEVD004J		LEVD004W	
<b>MV</b>						
MV AGUSTA F3 675	12	12	LEVD015J		LEVD015W	
<b>SUZUKI</b>						
SUZUKI tutte / all	04	03	LEVD004J		LEVD004W	
SUZUKI GSXR 600 / 750	01	12	LEVD009J		LEVD009W	
SUZUKI GSXR 1000	05	04	LEVD004J		LEVD004W	
SUZUKI GSXR 1000		12	LEVD009J		LEVD009W	
<b>TRIUMPH</b>						
TRIUMPH Boneville	06	12	LEVD004J		LEVD004W	
TRIUMPH Daytona 675	06	12	LEVD009J		LEVD009W	
TRIUMPH Daytona 675 R	09	12	LEVD010J		LEVD010W	
TRIUMPH Street Triple 675	07	12	LEVD004J		LEVD004W	
TRIUMPH Street Triple 675 R	08	12	LEVD009J		LEVD009W	
TRIUMPH Daytona Speed Triple 955	97	06	LEVD004J		LEVD004W	
TRIUMPH Scrambler	06	12	LEVD004J		LEVD004W	
TRIUMPH Speed Master	05	12	LEVD004J		LEVD004W	
TRIUMPH Speed Triple 1050	04	07	LEVD004J		LEVD004W	
TRIUMPH Speed Triple 1050 / 1050 R	08	12	LEVD010J		LEVD010W	
TRIUMPH Tiger 1050	07	12	LEVD004J		LEVD004W	
<b>YAMAHA</b>						
YAMAHA R6	99	04	LEVD004J		LEVD004W	
YAMAHA R6	05	12	LEVD010J		LEVD010W	
YAMAHA R1	98	03	LEVD004J		LEVD004W	
YAMAHA R1	04	12	LEVD010J		LEVD010W	
YAMAHA XJ6	09	12	LEVD013J		LEVD013W	
YAMAHA FZ6 / Fazer	04	12	LEVD013J		LEVD013W	
YAMAHA FZ1 / Fazer	06	12	LEVD013J		LEVD013W	
YAMAHA FZ8	10	12	LEVD013J		LEVD013W	

## Leve freno ribaltabile con regolazione da sinistra

Folding brake levers adjustable from left



Colori disponibili: nero. Available colours: black



modello - model	anno - years		codice - code <b>J</b>	€	codice - code <b>W</b>	€
	dal - from	al - to				
<b>BREMBO</b>						
BREMBO (16 x 18) (19 x 18)			LEVS502 <b>J</b>		LEVS502 <b>W</b>	
BREMBO (19 x 20)			LEVS503 <b>J</b>		LEVS503 <b>W</b>	
<b>APRILIA</b>						
APRILIA RSV1000	04	09	LEVS010 <b>J</b>		LEVS010 <b>W</b>	
APRILIA RSV4 R / FACTORY / APRC	09	12	LEVS010 <b>J</b>		LEVS010 <b>W</b>	
<b>BMW</b>						
BMW S1000 RR	09	12	LEVS012 <b>J</b>		LEVS012 <b>W</b>	
<b>DUCATI</b>						
DUCATI 749-999	02	06	LEVS010 <b>J</b>		LEVS010 <b>W</b>	
DUCATI 848-1098-1198	07	12	LEVS010 <b>J</b>		LEVS010 <b>W</b>	
DUCATI PANIGALE 1199	12	12	LEVS010 <b>J</b>		LEVS010 <b>W</b>	
<b>HONDA</b>						
HONDA CBR 600 RR	07	12	LEVS009 <b>J</b>		LEVS009 <b>W</b>	
HONDA CBR 1000 RR	04	12	LEVS009 <b>J</b>		LEVS009 <b>W</b>	



## Leve freno ribaltabile con regolazione da sinistra

Folding brake levers adjustable from left





modello - model	anno - years		codice - code <b>J</b>	€	codice - code <b>W</b>	€
	dal - from	al - to				
						
<b>KAWASAKI</b>						
KAWASAKI ZX6R		04	LEVS004J		LEVS004W	
KAWASAKI ZX6R	05	12	LEVS009J		LEVS009W	
KAWASAKI ZX10R	04	05	LEVS004J		LEVS004W	
KAWASAKI ZX10R	06	12	LEVS009J		LEVS009W	
<b>MV</b>						
MV AGUSTA F3 675	12	12	LEVS013J		LEVS013W	
<b>SUZUKI</b>						
SUZUKI tutte / all		03	LEVS004J		LEVS004W	
SUZUKI GSXR 600 / 750	04	12	LEVS009J		LEVS009W	
SUZUKI GSXR 1000	01	04	LEVS004J		LEVS004W	
SUZUKI GSXR 1000	05	12	LEVS009J		LEVS009W	
<b>TRIUMPH</b>						
TRIUMPH Daytona 675	06	12	LEVS009J		LEVS009W	
TRIUMPH Daytona 675 R	11	12	LEVS010J		LEVS010W	
<b>YAMAHA</b>						
YAMAHA R6	99	04	LEVS004J		LEVS004W	
YAMAHA R6	05	12	LEVS010J		LEVS010W	
YAMAHA R1	98	03	LEVS004J		LEVS004W	
YAMAHA R1	04	12	LEVS010J		LEVS010W	

## Leve frizione ribaltabile per snodo originale

Folding clutch levers for original joint



Colori disponibili: nero. Available colours: black

modello - model	anno - years		codice - code <b>J</b>	€	codice - code <b>W</b>	€
	dal - from	al - to				
						
<b>APRILIA</b>						
APRILIA RSV1000	04	09	LEVXF007J		LEVXF007W	
APRILIA RSV4 R / FACTORY / APRC	09	12	LEVXF001J		LEVXF001W	
APRILIA TUONO V4	11	12	LEVXF001J		LEVXF001W	
<b>BMW</b>						
BMW S1000 RR	09	12	LEVXF008J		LEVXF008W	
<b>DUCATI</b>						
DUCATI 749-999	02	06	LEVXF007J		LEVXF007W	
DUCATI 848-1098-1198	07	12	LEVXF007J		LEVXF007W	
DUCATI Monster 1100	10	12	LEVXF007J		LEVXF007W	
DUCATI Monster S4R	07	07	LEVXF007J		LEVXF007W	
DUCATI Streetfighter 848 / 1100	09	12	LEVXF007J		LEVXF007W	
DUCATI DIAVEL	11	12	LEVXF007J		LEVXF007W	
DUCATI PANIGALE 1199	12	12	LEVXF007J		LEVXF007W	
<b>HONDA</b>						
HONDA CBR 600 RR	03	12	LEVXF002J		LEVXF002W	
HONDA CBR 600 F	11	12	LEVXF002J		LEVXF002W	
HONDA CBR 1000 RR	04	07	LEVXF003J		LEVXF003W	
HONDA CBR 1000 RR	08	12	LEVXF002J		LEVXF002W	
HONDA CB 1000 R	08	12	LEVXF003J		LEVXF003W	
HONDA HORNET 600	11	12	LEVXF002J		LEVXF002W	
<b>KAWASAKI</b>						
KAWASAKI ZX6R	03	12	LEVXF004J		LEVXF004W	
KAWASAKI Z750	04	06	LEVXF005J		LEVXF005W	
KAWASAKI Z750	07	12	LEVXF004J		LEVXF004W	
KAWASAKI Z1000	03	12	LEVXF004J		LEVXF004W	
KAWASAKI Z1000 SX	11	12	LEVXF004J		LEVXF004W	
KAWASAKI ZX10R	04	12	LEVXF004J		LEVXF004W	
KAWASAKI Versys	06	12	LEVXF005J		LEVXF005W	
<b>MV</b>						
MV AGUSTA F3 675	12	12	LEVXF012J		LEVXF012W	

## Leve frizione ribaltabile per snodo originale

Folding clutch levers for original joint

modello - model	anno - years		codice - code <b>J</b>	€	codice - code <b>W</b>	€
	dal - from	al - to				
						
<b>SUZUKI</b>						
SUZUKI GSXR 600 / 750	06	10	LEVXF001J		LEVXF001W	
SUZUKI GSXR 600 / 750	11	12	LEVXF011J		LEVXF011W	
SUZUKI GSXR 1000	05	06	LEVXF001J		LEVXF001W	
SUZUKI GSXR 1000	07	08	LEVXF006J		LEVXF006W	
SUZUKI GSXR 1000	09	10	LEVXF001J		LEVXF001W	
SUZUKI GSXR 1000	11	12	LEVXF011J		LEVXF011W	
<b>TRIUMPH</b>						
TRIUMPH Boneville	06	12	LEVXF009J		LEVXF009W	
TRIUMPH Daytona 675	06	12	LEVXF009J		LEVXF009W	
TRIUMPH Daytona 675R	11	12	LEVXF009J		LEVXF009W	
TRIUMPH Street Triple 675	07	12	LEVXF009J		LEVXF009W	
TRIUMPH Street Triple 675 R	08	12	LEVXF009J		LEVXF009W	
TRIUMPH Scrambler	06	12	LEVXF009J		LEVXF009W	
TRIUMPH Speed Master	05	12	LEVXF009J		LEVXF009W	
TRIUMPH Speed Triple 1050 / 1050 R	04	12	LEVXF009J		LEVXF009W	
TRIUMPH Tiger 1050	07	12	LEVXF009J		LEVXF009W	
<b>YAMAHA</b>						
YAMAHA R6	00	12	LEVXF001J		LEVXF001W	
YAMAHA R1	00	12	LEVXF001J		LEVXF001W	
YAMAHA XJ6	09	12	LEVXF001J		LEVXF001W	
YAMAHA FZ6 / Fazer	04	12	LEVXF001J		LEVXF001W	
YAMAHA FZ8	10	12	LEVXF001J		LEVXF001W	
YAMAHA FZ1 / Fazer	06	12	LEVXF001J		LEVXF001W	



**FOR RACING USE ONLY**

Colori disponibili: nero. Available colours: black



modello - model	codice - code <b>J</b>	€	codice - code <b>W</b>	€
				
Leva frizione ribaltabile a cavo con bracciale Folding clutch lever (for cable clutch lever)	LEV7100J		LEV7100W	

## KIT leva



Lever KIT



Colori disponibili: nero. Available colours: black

modello - model	anno - years		codice - code <b>J</b>	€	codice - code <b>W</b>	€
	dal - from	al - to				
						
<b>APRILIA</b>						
APRILIA RSV1000	04	09	KLEV022J		KLEV022W	
APRILIA RSV4 R / FACTORY / APRC	09	12	KLEV021J		KLEV021W	
<b>BMW</b>						
BMW S1000 RR	09	12	KLEV020J		KLEV020W	
<b>DUCATI</b>						
DUCATI 749-999	02	06	KLEV022J		KLEV022W	
DUCATI 848-1098-1198	07	12	KLEV022J		KLEV022W	
DUCATI Streetfighter 848 / 1100	09	12	KLEV022J		KLEV022W	
DUCATI Monster 1100	10	12	KLEV022J		KLEV022W	
DUCATI DIAVEL	11	12	KLEV022J		KLEV022W	
DUCATI PANIGALE 1199	12	12	KLEV022J		KLEV022W	
<b>HONDA</b>						
HONDA HORNET 600	07	10	KLEV037J		KLEV037W	
HONDA CBR 600 RR	03	06	KLEV024J		KLEV024W	
HONDA CBR 600 RR	07	12	KLEV025J		KLEV025W	
HONDA CBR 1000 RR	04	07	KLEV023J		KLEV023W	
HONDA CBR 1000 RR	08	12	KLEV025J		KLEV025W	
HONDA CB 1000 R	08	12	KLEV023J		KLEV023W	
HONDA CBR 600 F	11	12	KLEV037J		KLEV037W	



modello - model	anno - years		codice - code <b>J</b>	€	codice - code <b>W</b>	€
	dal - from	al - to				
						
<b>KAWASAKI</b>						
KAWASAKI ZX6R	03	04	KLEV028J		KLEV028W	
KAWASAKI ZX6R	05	12	KLEV029J		KLEV029W	
KAWASAKI Z750	04	06	KLEV026J		KLEV026W	
KAWASAKI Z750	07	12	KLEV027J		KLEV027W	
KAWASAKI Z750 R	11	12	KLEV029J		KLEV029W	
KAWASAKI Z1000	03	06	KLEV028J		KLEV028W	
KAWASAKI Z1000	07	12	KLEV029J		KLEV029W	
KAWASAKI Z1000 SX	11	12	KLEV029J		KLEV029W	
KAWASAKI ZX10R	04	05	KLEV028J		KLEV028W	
KAWASAKI ZX10R	06	12	KLEV029J		KLEV029W	
KAWASAKI Versys	06	12	KLEV026J		KLEV026W	
<b>MV</b>						
MV AGUSTA F3 675	12	12	KLEV039J		KLEV039W	
<b>SUZUKI</b>						
SUZUKI GSXR 600 / 750	06	10	KLEV030J		KLEV030W	
SUZUKI GSXR 600 / 750	11	12	KLEV036J		KLEV036W	
SUZUKI GSXR 1000	05	06	KLEV030J		KLEV030W	
SUZUKI GSXR 1000	07	08	KLEV031J		KLEV031W	
SUZUKI GSXR 1000	09	10	KLEV030J		KLEV030W	
SUZUKI GSXR 1000	11	12	KLEV036J		KLEV036W	
<b>TRIUMPH</b>						
TRIUMPH Boneville	06	12	KLEV033J		KLEV033W	
TRIUMPH Daytona 675	06	12	KLEV032J		KLEV032W	
TRIUMPH Daytona 675 R	11	12	KLEV038J		KLEV038W	
TRIUMPH Street Triple 675	07	12	KLEV033J		KLEV033W	
TRIUMPH Street Triple 675 R	08	12	KLEV032J		KLEV032W	
TRIUMPH Scrambler	06	12	KLEV033J		KLEV033W	
TRIUMPH Speed Master	05	12	KLEV033J		KLEV033W	
TRIUMPH Speed Triple 1050	04	07	KLEV033J		KLEV033W	
TRIUMPH Speed Triple 1050 / 1050 R	08	12	KLEV038J		KLEV038W	
TRIUMPH Tiger 1050	07	12	KLEV033J		KLEV033W	
<b>YAMAHA</b>						
YAMAHA R6	05	12	KLEV021J		KLEV021W	
YAMAHA R1	04	12	KLEV021J		KLEV021W	
YAMAHA XJ6	09	12	KLEV034J		KLEV034W	
YAMAHA FZ6 / Fazer	04	12	KLEV034J		KLEV034W	
YAMAHA FZ1 / Fazer	06	12	KLEV034J		KLEV034W	
YAMAHA FZ8	10	12	KLEV034J		KLEV034W	
YAMAHA T-MAX	08	12	KLEV035			

## Ricambi leve

Lever spare parts



LEVA IN MAGNESIO - MAGNESIUM LEVER

codice - code

€

RLEV001J

Colori disponibili: nero. Available colours: black



LEVA IN MAGNESIO - MAGNESIUM LEVER

codice - code

€

RLEV001W

Colori disponibili: nero. Available colours: black



LEVA IN ERGAL - ERGAL LEVER  
per Brembo RCS for Brembo RCS

codice - code

€

RLEV016

Colori disponibili: nero. Available colours: black



REGISTRO LEVA FRENO - REMOTE BRAKE ADJUSTER  
con supporto with mounting clamp

codice - code

€

RLEV015

Colori disponibili: nero. Available colours: black



CAVO DI REGOLAZIONE - CABLE FOR REMOTE ADJUSTER

codice - code

€

A	RLEV005	
B	RLEV008	
C	RLEV014	
D	RLEV009	

Handlebar holders



Ø forcella Ø Fork	° Inclinazione gradi ° Inclination grade	codice code	€
			a coppia - for pair
		H = 0 mm	
Ø 48	10	MOZ4810	
Ø 50	10	MOZ5010	
Ø 51	5	MOZ5110	
Ø 52	5	MOZ5210	
Ø 53	10	MOZ5310	
Ø 55	5	MOZ5510	

Colori disponibili: nero. Available colours: black

Ø forcella Ø Fork	° Inclinazione gradi ° Inclination grade	codice code	€
			a coppia - for pair
		H = + 20 mm	
Ø 48	10	MOZ4820	
Ø 50	10	MOZ5020	
Ø 51	5	MOZ5120	
Ø 52	5	MOZ5220	
Ø 53	10	MOZ5320	
Ø 55	5	MOZ5520	

Colori disponibili: nero. Available colours: black

APPLICAZIONI MOZZETTI - CLIP-ONS APPLICATION LIST	anno - years		diametro - diameter
	dal - from	al - to	
APRILIA RSV 1000	00	05	51
APRILIA RSV 1000 / FACTORY	06	09	50
APRILIA RSV4 R / FACTORY / APRC	09	12	50
BMW S 1000 RR	09	12	55
DUCATI 748 / 749 / 916 / 998 / 999	94	06	53
DUCATI 848	07	12	53
DUCATI 1098	07	11	53
HONDA CBR 600 RR	07	12	48
HONDA CBR 1000 RR	04	12	50
KAWASAKI ZX 6 R / 636	03	08	50
KAWASAKI ZX 6 R	09	12	51
KAWASAKI ZX 10 R	04	12	50
SUZUKI GSXR 600 / 750	06	07	48
SUZUKI GSXR 600 / 750	08	12	50
SUZUKI GSXR 1000	05	12	50
TRIUMPH DAYTONA 675 / 675 R	07	12	50
YAMAHA R6	06	12	50
YAMAHA R1	04	12	50



SEMIMANUBRIO - HANDLEBAR TUBES

codice - code	€
	a coppia - for pair
HBT001	
lunghezza 280 mm - length 280 mm	







**ACCESSORI  
MANUBRIO**  
HANDLEBAR  
ACCESSORIES

## Contrappesi manubri

Handlebar balancers

NEW





*Black & White Series*



*Devil Series*



Colori disponibili: nero, silver e rosso. Available colours: black, silver and red.

modello - model	anno - years		misura - measure	codice - code			€ a coppia / for pair
	dal - from	al - to					
UNIVERSALE / universal			ø 12 / 13 / 17	KTM300NER	KTM300SIL	KTM300ROS	
APRILIA RSV4	09	12		KTM303NER	KTM303SIL	KTM303ROS	
APRILIA RSV1000	04	08		KTM313NER	KTM313SIL	KTM313ROS	
APRILIA Shiver 750	07	12		KTM313NER	KTM313SIL	KTM313ROS	
APRILIA Tuono	06	09		KTM313NER	KTM313SIL	KTM313ROS	
APRILIA Tuono V4	11	12		KTM313NER	KTM313SIL	KTM313ROS	
BMW S1000RR	09	12		KTM314NER	KTM314SIL	KTM314ROS	
DUCATI S4 - ST2	07	07		KTM304NER	KTM304SIL	KTM304ROS	
DUCATI Multistrada	03	09		KTM305NER	KTM305SIL	KTM305ROS	
DUCATI 848	08	11	d. 12	KTM301NER	KTM301SIL	KTM301ROS	
DUCATI 1098 / 1198	07	11	d. 17	KTM302NER	KTM302SIL	KTM302ROS	
DUCATI DIAVEL	11	12	d. 12	KTM301NER	KTM301SIL	KTM301ROS	
DUCATI 1199 Panigale	12	12		KTM318NER	KTM318SIL	KTM318ROS	
HONDA - tutte / all	..	..		KTM306NER	KTM306SIL	KTM306ROS	
KAWASAKI ER-6N	12	12		KTM304NER	KTM304SIL	KTM304ROS	
KAWASAKI ZX250R	09	12		KTM307NER	KTM307SIL	KTM307ROS	
KAWASAKI Z750	04	12		KTM304NER	KTM304SIL	KTM304ROS	
KAWASAKI Z1000	03	12		KTM304NER	KTM304SIL	KTM304ROS	
KAWASAKI Z1000 SX	11	12		KTM304NER	KTM304SIL	KTM304ROS	
KAWASAKI ZX6R	03	12		KTM304NER	KTM304SIL	KTM304ROS	
KAWASAKI ZX10R	11	12		KTM304NER	KTM304SIL	KTM304ROS	
MV AGUSTA F3	11	12		KTM316NER	KTM316SIL	KTM316ROS	
SUZUKI Gladius 650	09	12		KTM309NER	KTM309SIL	KTM309ROS	
SUZUKI GSR 600	06	11		KTM305NER	KTM305SIL	KTM305ROS	
SUZUKI GSR 750	11	12		KTM305NER	KTM305SIL	KTM305ROS	
SUZUKI GSXR 600 / 750	00	05		KTM305NER	KTM305SIL	KTM305ROS	
SUZUKI GSXR 600 / 750	06	12		KTM309NER	KTM309SIL	KTM309ROS	
SUZUKI GSXR 1000	03	04		KTM305NER	KTM305SIL	KTM305ROS	
SUZUKI GSXR 1000	05	12		KTM309NER	KTM309SIL	KTM309ROS	
YAMAHA Fazer 600 - FZ6	04	06		KTM310NER	KTM310SIL	KTM310ROS	
YAMAHA Fazer 1000	01	12		KTM310NER	KTM310SIL	KTM310ROS	
YAMAHA T Max	02	12		KTM310NER	KTM310SIL	KTM310ROS	
YAMAHA TDM 900	02	08		KTM310NER	KTM310SIL	KTM310ROS	
YAMAHA R 125	08	12		KTM310NER	KTM310SIL	KTM310ROS	
YAMAHA R1	98	12		KTM311NER	KTM311SIL	KTM311ROS	
YAMAHA R6	00	05		KTM312NER	KTM312SIL	KTM312ROS	
YAMAHA R6	06	12		KTM311NER	KTM311SIL	KTM311ROS	



codice - code: RKT300

Colori disponibili: oro, rosso, nero, silver, indaco. Available colours: gold, red, black, silver, indigo.

a coppia / for pair



Colori disponibili: oro, rosso, nero, silver, indaco, blu. Available colours: gold, red, black, silver, indigo, blue.

modello - model	anno - years		misura - measure	codice - code	€ a coppia for pair
	dal - from	al - to			
UNIVERSALE / universal			ø 12 / 13 / 17	KTM100	
APRILIA RSV4	09	12		KTM003	
APRILIA RSV1000	04	08		KTM013	
APRILIA Shiver 750	07	12		KTM013	
APRILIA Tuono	06	09		KTM013	
APRILIA Tuono V4	11	12		KTM013	
BMW S1000RR	09	12		KTM014	
BMW R 1200 GS	08	12		KTM015	
DUCATI S4 - ST2	07	07		KTM004	
DUCATI Multistrada	03	09		KTM005	
DUCATI 848	08	11	d. 12	KTM001	
DUCATI 1098 / 1198	07	11	d. 17	KTM002	
DUCATI DIAVEL	11	12	d. 12	KTM001	
DUCATI 1199 Panigale	12	12		KTM018	
HONDA - tutte/all	..	..		KTM006	
KAWASAKI ER-6N	12	12		KTM004	
KAWASAKI ZX250R	09	12		KTM007	
KAWASAKI Z750	04	12		KTM004	
KAWASAKI Z1000	03	12		KTM004	
KAWASAKI Z1000 SX	11	12		KTM004	
KAWASAKI ZX6R	03	12		KTM004	
KAWASAKI ZX10R	11	12		KTM004	
MV AGUSTA F3	11	12		KTM016	
SUZUKI Gladius 650	09	12		KTM009	
SUZUKI GSR 600	06	11		KTM005	
SUZUKI GSR 750	11	12		KTM005	
SUZUKI GSXR 600 / 750	00	05		KTM005	
SUZUKI GSXR 600 / 750	06	12		KTM009	
SUZUKI GSXR 1000	03	04		KTM005	
SUZUKI GSXR 1000	05	12		KTM009	
YAMAHA Fazer 600 - FZ6	04	06		KTM010	
YAMAHA Fazer 1000	01	12		KTM010	
YAMAHA T Max	02	12		KTM010	
YAMAHA TDM 900	02	08		KTM010	
YAMAHA R 125	08	12		KTM010	
YAMAHA R1	98	12		KTM011	
YAMAHA R6	00	05		KTM012	
YAMAHA R6	06	12		KTM011	

## Regolatori molla forcella

Fork spring adjusters



Colori disponibili: oro, rosso, nero, silver, indaco, blu. Available colours: gold, red, black, silver, indigo, blue.

modello - model	ø mm	anno - years		codice - code	€
		dal - from	al - to		
APRILIA RSV4 Factory	17	09	12	REG001	
APRILIA RSV4 R	22	10	12	REG002	
APRILIA RSV 1000	17	04	05	REG001	
APRILIA TUONO	22	06	09	REG002	
BMW S1000 RR	17	09	12	REG001	
DUCATI MONSTER 696	17	08	12	REG001	
DUCATI 848 / 1098 / 1198	22	07	11	REG002	
DUCATI 1098S / 1198S	17	07	17	REG001	
DUCATI 748 / 916 / 996 / 749 / 999	22	00	06	REG002	
GUZZI GRISO	22	06	07	REG002	
HONDA CBR 1000	22	04	07	REG002	
HONDA CBR 1000	19	08	11	REG003	
HONDA CB 1000 R	19	08	12	REG003	
HONDA CBR 600	22	05	06	REG002	
HONDA CBR 600	19	07	12	REG003	
KAWASAKI Z1000	22	03	06	REG002	
KAWASAKI ZX6R	14	03	04	REG004	
KAWASAKI ZX6R	22	05	06	REG002	
KAWASAKI ZX6R	19	07	08	REG003	
KAWASAKI ZX10R	-	04	05	REG005	
KAWASAKI ZX10R	14	06	10	REG004	
MV AGUSTA F4	19	00	09	REG003	
MV AGUSTA F3	22	12	12	REG002	
SUZUKI GSXR 600 / 750	22	04	05	REG002	
SUZUKI GSXR 600 / 750	19	06	10	REG003	
SUZUKI GSXR 1000	14	03	08	REG004	
TRIUMPH SPEED TRIPLE 1050	22	05	10	REG002	
TRIUMPH STREET TRIPLE 675	22	07	12	REG002	
TRIUMPH DAYTONA 675	14	07	12	REG004	
YAMAHA R6	17	03	04	REG001	
YAMAHA R6	14	05	05	REG004	
YAMAHA R6	17	06	07	REG001	
YAMAHA R6	14	08	12	REG004	
YAMAHA R1	-	04	12	REG005	
YAMAHA FZ1	14	06	12	REG004	





**SPECCHIETTI**  
MIRRORS

## Specchietti in alluminio per naked

Aluminium mirrors for naked



Colori disponibili: nero, rosso. Available colours: black, red.

articolo - article	colore - color	codice - code	€
			a coppia - for pair
Coppia specchi alluminio (filetto 2xM10x1,25 R + 1xM10x1,25 L) Aluminium mirrors couple (thread 2xM10x1,25 R + 1xM10x1,25 L)	nero-black	SPEAL014NER	
	rosso-red	SPEAL014ROS	
Coppia specchi alluminio DUCATI Streetfighter (filetto M 8 x 1,25 dx + sx ) Aluminium mirrors couple DUCATI Streetfighter (thread M 8 x 1,25 dx + sx )	nero-black	SPEAL014DNER	
	rosso-red	SPEAL014DROS	

**NEW**



**HOMOLOGATED**



Colori disponibili: nero. Available colours: black.

articolo - article	colore - color	codice - code	€
			a coppia - for pair
Coppia specchi alluminio (filetto 2xM10x1,25 R + 1xM10x1,25 L) Aluminium mirrors couple (thread 2xM10x1,25 R + 1xM10x1,25 L)	nero-black	SPEAL023NER	
Coppia specchi alluminio DUCATI Streetfighter (filetto M 8 x 1,25 dx + sx ) Aluminium mirrors couple DUCATI Streetfighter (thread M 8 x 1,25 dx + sx )	nero-black	SPEAL023DNER	

**NEW**

**Specchietti in carbonio**

Carbon mirrors

47

## GEMINI SERIES



**COMING SOON!**

- 
- **GEMINI: THE NEW MODEL FOR THE NEXT SEASON**
  - **ITALIAN DESIGN**
  - **MATERIAL: FULL CARBON**
  - **TWO VERSIONS: WITH OR WITHOUT INDICATOR**
  - **ALL MADE IN ITALY**
  - **DEDICATED TO SPORT BIKE**

## Specchietti in carbonio

Carbon mirrors



articolo - article	anno - years		codice - code	€ a coppia - for pair
	dal - from	al - to		
Base piccola (interasse da 27,5mm a 39mm) Small adaptor (distance between holes 27,5 mm to 39 mm)			SPEC4	
Base grande (interasse da 54,5mm a 69,5mm) Big adaptor (distance between holes 54,5 mm to 69,5 mm)			SPEC2	
Base Ducati 748 - 916 - 996 - 998 Adaptor Ducati 748 - 916 - 996 - 998			SPEC3	
APRILIA RSV4 R / FACTORY / APRC	09	12	SPEAP001	
DUCATI PANIGALE 1199	12	12	SPEDU001	
HONDA CBR 1000 RR	08	12	SPEHO001	
KAWASAKI ZX6R	09	12	SPEKA001	
KAWASAKI ZX 10R	11	12	SPEKA002	

ADATTATORI SPECCHIO MIRRORS ADAPTOR	anno - years		codice code	€ a coppia - for pair
	dal - from	al - to		
Base grande - Big adaptor			SPEP2	
Base Ducati - Adaptor Ducati			SPEP3	
Base piccola - Small adaptor			SPEP4	
Aprilia RSV 4	09	12	SPEP6	
Ducati Panigale 1199	12	12	SPEP8	
Honda CBR 1000	08	12	SPEP5	
Kawasaki ZX6 R	09	12	SPEP7	
Kawasaki ZX10 R	11	12	SPEP9	
Yamaha R6	08	12	SPEY05	

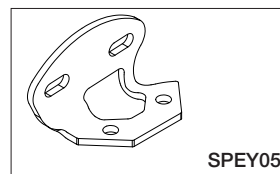
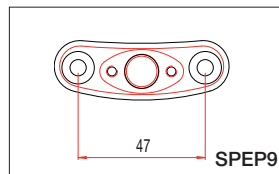
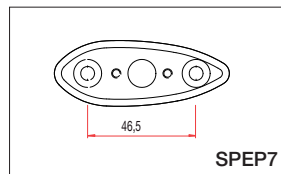
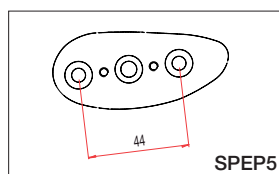
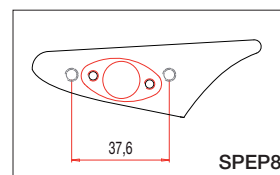
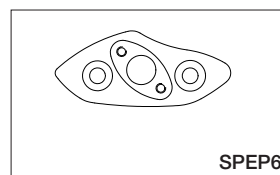
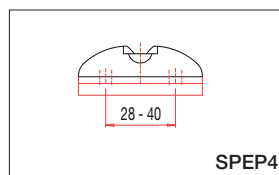
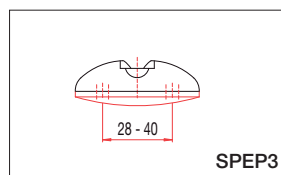
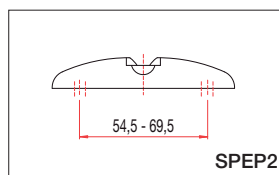



## Tappi specchio

### Mirror block-off plates



Colori disponibili: indaco, rosso, oro, nero, blu, silver. Available colours: indigo, red, gold, black, blue, silver.

articolo - article	anno - years		codice - code	€
	dal - from	al - to		a coppia - for pair
APRILIA RSV4 + Factory	09	12	SPE111	
BMW S1000 RR	09	12	SPE101	
DUCATI PANIGALE 1199	12	12	SPE113	
HONDA CBR 600 RR	04	12	SPE105	
HONDA CBR 1000 RR	04	07	SPE105	
HONDA CBR 1000 RR	08	12	SPE106	
KAWASAKI ZX6R	03	04	SPE101	
KAWASAKI ZX6R	05	08	SPE102	
KAWASAKI ZX6R	09	12	SPE110	
KAWASAKI ZX10R	04	07	SPE102	
KAWASAKI ZX10R	08	10	SPE108	
KAWASAKI ZX10R	11	12	SPE112	
SUZUKI GSXR 600 / 750 / 1000	05	12	SPE103	
YAMAHA R6	99	07	SPE104	
YAMAHA R1	98	06	SPE104	
YAMAHA R1	07	12	SPE101	



**BMW  
R1200GS**



**TRIUMPH  
SPEED TRIPLE**



**T-MAX 530**



**APRILIA  
RSV4**







**PORTA TARGA**  
LICENSE PLATE  
BRACKETS

## Porta targa regolabili

Adjustable license plate brackets

- 1** Materiale ultra-resistente (Polimero PA12 arricchito con fibra di carbonio)  
Ultra resistant material (Polymer PA12 enriched with carbon fiber)
- 2** Struttura rinforzata  
Strengthened structure
- 3** Supporto catadiottro  
Reflector holder
- 4** Fori fissaggio luce targa  
License plate light mounting holes
- 5** Supporto metallico  
Metal holder



Semplicità nel montaggio  
Easy assembling

## Nel pieno rispetto del codice della strada

Abiding in full by the street code

**HOMOLOGATED**





## Porta targa regolabili

## Adjustable license plate brackets

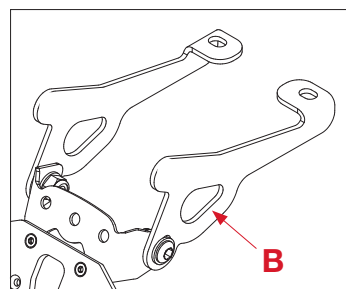
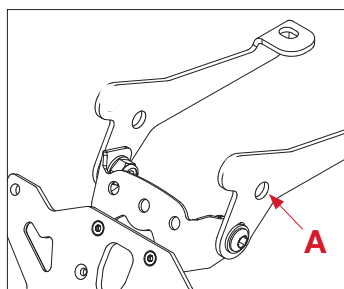

- A** = predisposizione montaggio freccia piccola / with hole for little indicator  
**B** = predisposizione montaggio freccia standard / with hole for standard indicator  
**C** = predisposizione montaggio luce targa / with hole for number plate support's light  
**D** = con faro posteriore / with rear stop position light

**N** = DESINENZA NAZIONE DA AGGIUNGERE AL CODICE / ADD THE ABBREVIATION OF NATIONALITY TO THE CODE

IT = Italia  CH = Schweiz  CA = Canada  P = Portugal  F = France   
 USA = United S.  E = España  SLO = Slovenija  AUS = Australia  DE = Deutschland 

modello - model	anno - years		A	B	C	D	codice - code	N	€
	dal - from	al - to							
<b>APRILIA</b>									
APRILIA RS 125	05	11	X				TARAP106	---	
APRILIA RSV 1000	04	05			NO		TARAP101	---	
APRILIA RSV4 / Factory	09	12	X		X		TARAP102	---	
APRILIA Tuono	06	09			NO		TARAP101	---	
APRILIA Tuono V4	11	12	X		X		TARAP102	---	
APRILIA Dorsoduro 750	08	12	X	X	X		TARAP103	---	
APRILIA Dorsoduro 1200	11	12	X	X	X		TARAP104	---	
APRILIA SHIVER 750	07	12	X	X	X		TARAP105	---	
<b>BMW</b>									
BMW S1000RR	09	12	X	X	X		TARBM101	---	
BMW F800R	10	10			NO		TARBM102	---	
BMW R 1200 GS	08	12		X	NO		TARBM103	---	
<b>DUCATI</b>									
DUCATI Monster	03	07			X		TARDU101	---	
DUCATI Monster 696	08	12	X		NO	X	TARDU107	---	
DUCATI Monster 796 - 1100	10	12	X		NO	X	TARDU107	---	
DUCATI 749 - 999	02	06			X		TARDU103	---	
DUCATI 848 - 1098 - 1198	07	11	X	X	X		TARDU104	---	
DUCATI Hypermotard 796 - 1100	07	12	X		X		TARDU105	---	
DUCATI Multistrada 1200S*	10	12	X	X	X		TARDU108	---	
DUCATI Streetfighter 848 / 1100	09	12	X	X	X		TARDU106	---	
DUCATI 1199 Panigale**	12	12	X		X		TARDU109	---	
<b>GUZZI</b>									
MOTO GUZZI GRISO 850 / 1100	06	10	X	X	X		TARGU101	---	
<b>HONDA</b>									
HONDA INTEGRA 700	12	12	X		NO		TARHO110	---	
HONDA CBR 600 RR	05	06	X	X	X	X	TARHO102	---	
HONDA CBR 600 RR	07	12	X		NO		TARHO103	---	
HONDA CBR 1000 RR	04	05	X	X	X	X	TARHO102	---	
HONDA CBR 1000 RR	06	07	X	X	X		TARHO104	---	
HONDA CBR 1000 (no ABS)	08	09	X		NO		TARHO105	---	
HONDA CBR 1000 RR	10	11	X		X	X	TARHO106	---	
HONDA CBR 1000 RR	12	12	X		X		TARHO109	---	
HONDA CB 1000 R	08	12	X		X		TARHO107	---	
HONDA HORNET 600	07	10	X		X		TARHO101	---	
HONDA HORNET 600	11	12	X		X		TARHO108	---	
HONDA CBR 600 F	11	12	X		X		TARHO108	---	
<b>HUSQVARNA</b>									
HUSQVARNA NUDA 900	12	12	X		X		TARHU101	---	

\* No borse laterali / Not for side travelsuit case

\*\* Colori disponibili: rosso e nero / Available colours: red and black

## Porta targa regolabili

Adjustable license plate brackets

modello - model	anno - years		A	B	C	D	codice - code	N	€
	dal - from	al - to							
<b>KAWASAKI</b>									
KAWASAKI 250R	09	12	X	X	X		TARKA101	---	
KAWASAKI ZX6R	03	04	X	X	X		TARKA102	---	
KAWASAKI ZX6R	05	06	X		X		TARKA103	---	
KAWASAKI ZX6R	07	08	X		NO	X	TARKA104	---	
KAWASAKI ZX6R	09	12	X		X		TARKA105	---	
KAWASAKI ZX10R	04	05	X	X	X		TARKA106	---	
KAWASAKI ZX10 R	06	07			X		TARKA107	---	
KAWASAKI ZX10 R	08	10	X		X		TARKA105	---	
KAWASAKI ZX10 R	11	12			X		TARKA113	---	
KAWASAKI ER - 6N	06	08	X	X	X		TARKA106	---	
KAWASAKI ER - 6N	09	11	X		X		TARKA108	---	
KAWASAKI ER - 6N	12	12		X	X		TARKA116	---	
KAWASAKI Z 750	04	06	X	X	X		TARKA102	---	
KAWASAKI Z 750	07	12	X		X		TARKA109	---	
KAWASAKI Z 1000	03	06	X	X	X		TARKA102	---	
KAWASAKI Z 1000	07	09	X		X		TARKA109	---	
KAWASAKI Z 1000	10	12	X		X		TARKA110	---	
KAWASAKI Z 1000	10	12		X	X		TARKA111	---	
KAWASAKI Z 1000 SX	11	12		X	X		TARKA114	---	
KAWASAKI Z 1000 SX	11	12	X		X		TARKA115	---	
KAWASAKI VERSYS 650	10	12	X	X	X		TARKA112	---	
<b>KTM</b>									
KTM 690 SM / 690 SMR	07	10	X		X		TARKT101	---	
KTM DUKE 690	12	12	X			X	TARKT103	---	
KTM Super Duke 990	07	11	X		X		TARKT102	---	
<b>MORINI</b>									
MORINI CORSARO	06	10	X		X		TARMO101	---	
<b>MV</b>									
MV Brutale 750 / 910	01	10	X		X		TARMV101	---	
MV AGUSTA F3 675	12	12	X		X		TARMV104	---	
MV AGUSTA BRUTALE B3 675	12	12	X		X		TARMV105	---	
MV AGUSTA F4	00	09	X		X		TARMV102	---	
MV AGUSTA F4	10	12	X	X	X		TARMV103	---	
<b>SUZUKI</b>									
SUZUKI GSXR 1000	05	08			X		TARSU101	---	
SUZUKI GSXR 1000	09	12			X		TARSU102	---	
SUZUKI GSXR 600 / 750	06	07			X		TARSU103	---	
SUZUKI GSXR 600 / 750	08	10			X		TARSU104	---	
SUZUKI GSXR 600 / 750	11	12			X		TARSU109	---	
SUZUKI GSR 600	06	11	X		X		TARSU105	---	
SUZUKI GSR 750	11	12	X		X		TARSU110	---	
SUZUKI SV 650 / 650S	03	08	X		X		TARSU106	---	
SUZUKI SV 1000	04	06	X		X		TARSU106	---	
SUZUKI GLADIUS	09	12	X	X	NO	X	TARSU108	---	
<b>TRIUMPH</b>									
TRIUMPH Speed Triple 1050	08	10	X		NO	X	TARTR102	---	
TRIUMPH Speed Triple 1050 / 1050R	11	12	X		X		TARTR105	---	
TRIUMPH Street Triple 675 / 675R	07	12	X		X		TARTR103	---	
TRIUMPH DAYTONA 675 / 675R	07	12	X		X		TARTR104	---	
<b>YAMAHA</b>									
YAMAHA R 125	08	12	X	X	X		TARYA101	---	
YAMAHA R6	06	12	X		X		TARYA102	---	
YAMAHA R6	06	12		X	X		TARYA103	---	
YAMAHA R1	04	08	X		X		TARYA102	---	
YAMAHA R1	04	08		X	X		TARYA103	---	
YAMAHA R1	09	12	X		X		TARYA104	---	
YAMAHA R1	09	12		X	X		TARYA105	---	
YAMAHA Fazer 600 / FZ6	04	12	X		X		TARYA106	---	
YAMAHA Fazer 600 / FZ6	04	12		X	X		TARYA107	---	
YAMAHA XJ6	08	12	X	X	X		TARYA108	---	
YAMAHA FZ1 / FAZER 1000	06	12	X	X	X		TARYA109	---	
YAMAHA FZ8	10	12	X	X	X		TARYA109	---	
YAMAHA T - MAX	04	07			X		TARYA111	---	
YAMAHA T - MAX (con sottocodone / with undertail)	08	11			X		TARYA112	---	
YAMAHA T - MAX (senza sottocodone / without undertail)	08	11			X		TARYA113	---	
YAMAHA T - MAX 530	12	12			X		TARYA114	---	



## KIT porta targa regolabili

Adjustable license plate brackets KIT



- A** = predisposizione montaggio freccia piccola / with hole for little indicator  
**B** = predisposizione montaggio freccia standard / with hole for standard indicator  
**C** = con luce targa / with plate support's light  
**D** = con faro posteriore / with rear stop position light

**N** = DESINENZA NAZIONE DA AGGIUNGERE AL CODICE / ADD THE ABBREVIATION OF NATIONALITY TO THE CODE

IT = Italia  CH = Schweiz  CA = Canada  P = Portugal  F = France   
 USA = United S.  E = España  SLO = Slovenija  AUS = Australia  DE = Deutschland 

modello - model	anno - years		A	B	C	D	codice - code	N	€
	dal - from	al - to							
<b>APRILIA</b>									
APRILIA RS 125	05	11	X				KTARAP106	---	
APRILIA RSV 1000	04	05			NO		KTARAP101	---	
APRILIA RSV4 / Factory	09	12	X		X		KTARAP102	---	
APRILIA Tuono	06	09			NO		KTARAP101	---	
APRILIA Tuono V4	11	12	X		X		KTARAP102	---	
APRILIA Dorsoduro 750	08	12	X	X	X		KTARAP103	---	
APRILIA Dorsoduro 1200	11	12	X	X	X		KTARAP104	---	
APRILIA SHIVER 750	07	12	X	X	X		KTARAP105	---	
<b>BMW</b>									
BMW S1000RR	09	12	X	X	X		KTARBM101	---	
BMW F800R	10	10			NO		KTARBM102	---	
<b>DUCATI</b>									
DUCATI Monster	03	07			X		KTARDU101	---	
DUCATI Monster 696	08	12	X		NO		KTARDU107	---	
DUCATI Monster 796 / 1100	10	12	X		NO	X	KTARDU107	---	
DUCATI 749 / 999	02	06			X	X	KTARDU103	---	
DUCATI 848 / 1098 / 1198	07	11	X	X	X		KTARDU104	---	
DUCATI Hypermotard 796 / 1100	07	12	X		X		KTARDU105	---	
DUCATI Multistrada 1200S*	10	12	X	X	X		KTARDU108	---	
DUCATI Streetfighter 1100 / 848	09	12	X	X	X		KTARDU106	---	
DUCATI 1199 Panigale**	12	12	X		X		KTARDU109	---	
<b>GUZZI</b>									
MOTO GUZZI GRISO	06	10	X	X	X		KTARGU101	---	
<b>HONDA</b>									
HONDA INTEGRA 700	12	12	X		NO		KTARHO110	---	
HONDA CBR 600 RR	05	06	X	X	X	X	KTARHO102	---	
HONDA CBR 600 RR	07	12	X		NO		KTARHO103	---	
HONDA CBR 1000 RR	04	05	X	X	X	X	KTARHO102	---	
HONDA CBR 1000 RR	06	07	X	X	X		KTARHO104	---	
HONDA CBR 1000 RR (no ABS)	08	09	x		NO		KTARHO105	---	
HONDA CBR 1000 RR	10	11	X		X	X	KTARHO106	---	
HONDA CBR 1000 RR	12	12	X		X		KTARHO109	---	
HONDA CB 1000R	08	12	X		X		KTARHO107	---	
HONDA HORNET 600	07	10	X		X		KTARHO101	---	
HONDA HORNET 600	11	12	X		X		KTARHO108	---	
HONDA CBR 600 F	11	12	X		X		KTARHO108	---	
<b>HUSQVARNA</b>									
HUSQVARNA NUDA 900	12	12	X		X		KTARHU101	---	

\* No borse laterali / Not for side travelsuit case

\*\* Colori disponibili: rosso e nero / Available colours: red and black

## KIT porta targa regolabili

Adjustable license plate brackets KIT

modello - model	anno - years		A	B	C	D	codice - code	N	€
	dal - from	al - to							
<b>KAWASAKI</b>									
KAWASAKI 250R	09	12	X	X	X		KTARKA101	---	
KAWASAKI ZX6R	03	04	X	X	X		KTARKA102	---	
KAWASAKI ZX6R	05	06	X		X		KTARKA103	---	
KAWASAKI ZX6R	07	08	X		NO	X	KTARKA104	---	
KAWASAKI ZX6R	09	12	X		X		KTARKA105	---	
KAWASAKI ZX10R	04	05	X	X	X		KTARKA106	---	
KAWASAKI ZX10 R	06	07			X		KTARKA107	---	
KAWASAKI ZX10 R	08	10	X		X		KTARKA105	---	
KAWASAKI ZX10 R	11	12			X		KTARKA113	---	
KAWASAKI ER - 6N	06	08	X	X	X		KTARKA106	---	
KAWASAKI ER - 6N	09	10	X		X		KTARKA108	---	
KAWASAKI ER - 6N	12	12	X	X	X		KTARKA116	---	
KAWASAKI Z 750	04	06	X	X	X		KTARKA102	---	
KAWASAKI Z 750	07	12	X		X		KTARKA109	---	
KAWASAKI Z 1000	03	06	X	X	X		KTARKA102	---	
KAWASAKI Z 1000	07	09	X		X		KTARKA109	---	
KAWASAKI Z 1000	10	12	X		X		KTARKA110	---	
KAWASAKI Z 1000	10	12		X	X		KTARKA111	---	
KAWASAKI Z 1000 SX	11	12		X	X		KTARKA114	---	
KAWASAKI Z 1000 SX	11	12	X		X		KTARKA115	---	
KAWASAKI VERSYS 650	10	12	X	X	X		KTARKA112	---	
<b>KTM</b>									
KTM 690 SM / 690 SMR	07	10	X		X		KTARKT101	---	
KTM 690	12	12	X			X	KTARKT103	---	
KTM Super Duke 990	07	11	X		X		KTARKT102	---	
<b>MORINI</b>									
MORINI CORSARO	06	10	X		X		KTARMO101	---	
<b>MV</b>									
MV Brutale 750 / 910	01	10	X		X		KTARMV101	---	
MV AGUSTA F3 675	12	12	X		X		KTARMV104	---	
MV AGUSTA BRUTALE	12	12	X		X		KTARMV105	---	
MV AGUSTA F4	00	09	X		X		KTARMV102	---	
MV AGUSTA F4	10	12	X	X	X		KTARMV103	---	
<b>SUZUKI</b>									
SUZUKI GSXR 1000	05	08			X		KTARSU101	---	
SUZUKI GSXR 1000	09	12			X		KTARSU102	---	
SUZUKI GSXR 600 / 750	06	07			X		KTARSU103	---	
SUZUKI GSXR 600 / 750	08	10			X		KTARSU104	---	
SUZUKI GSXR 600 / 750	11	12			X		KTARSU109	---	
SUZUKI GSR 600	06	11	X		X		KTARSU105	---	
SUZUKI GSR 750	11	12	X		X		KTARSU110	---	
SUZUKI SV 650 / 650S	03	08	X		X		KTARSU106	---	
SUZUKI SV 1000	04	06	X		X		KTARSU106	---	
SUZUKI GLADIUS	09	12	X	X	NO	X	KTARSU108	---	
<b>TRIUMPH</b>									
TRIUMPH Speed Triple 1050	08	10	X		NO	X	KTARTR102	---	
TRIUMPH Speed Triple 1050 / 1050R	11	12	X		X		KTARTR105	---	
TRIUMPH Street Triple 675 / 675R	07	12	X		X		KTARTR103	---	
TRIUMPH DAYTONA 675 / 675R	07	12	X		X		KTARTR104	---	
<b>YAMAHA</b>									
YAMAHA R 125	08	12	X	X	X		KTARYA101	---	
YAMAHA R6	06	12	X		X		KTARYA102	---	
YAMAHA R6	06	12		X	X		KTARYA103	---	
YAMAHA R1	04	08	X		X		KTARYA102	---	
YAMAHA R1	04	08		X	X		KTARYA103	---	
YAMAHA R1	09	12	X		X		KTARYA104	---	
YAMAHA R1	09	12		X	X		KTARYA105	---	
YAMAHA Fazer 600 / FZ6	04	12	X		X		KTARYA106	---	
YAMAHA Fazer 600 / FZ6	04	12		X	X		KTARYA107	---	
YAMAHA XJ6	08	12	X	X	X		KTARYA108	---	
YAMAHA FZ1 / FAZER 1000	06	12	X	X	X		KTARYA109	---	
YAMAHA FZ8	10	12	X	X	X		KTARYA109	---	
YAMAHA T - MAX	04	07			X		KTARYA111	---	
YAMAHA T - MAX (con sottocodone / with undertail)	08	11			X		KTARYA112	---	
YAMAHA T - MAX (senza sottocodone / without undertail)	08	11			X		KTARYA113	---	
YAMAHA T - MAX 530	12	12			X		KTARYA114	---	





**Indicatori di direzione a led - Led turn signals**



**HOMOLOGATED** E 6

**codice-code:** FRE905NER  
nero - black      **a coppia** - for pair



**HOMOLOGATED** E 6

**codice-code:** FRE906NER  
nero - black      **a coppia** - for pair



**HOMOLOGATED** E 6

**codice-code:** FRE907NER  
nero - black      **a coppia** - for pair

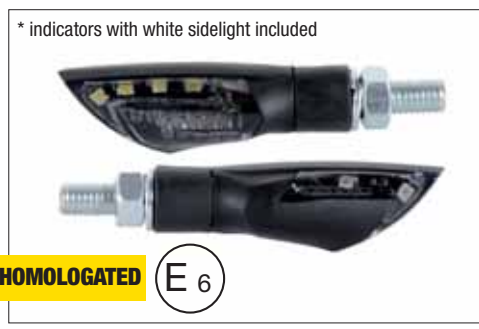

**HOMOLOGATED** E 6

**codice-code:** FRE908NER\*  
nero - black      **a coppia** - for pair



**HOMOLOGATED** E 6

**codice-code:** FRE909NER\*  
nero - black      **a coppia** - for pair

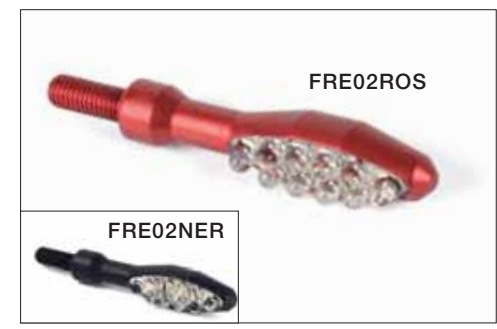

**codice-code:** FRE02  
rosso - red / nero - black      **a coppia** - for pair

**Fanalino targa - License plate light**



**HOMOLOGATED** E 4

**codice-code:** PTLA2

**Kit resistenza - Kit resistance**



**codice-code:** FRERES  
**a coppia** - for pair

### Fanalino targa - License plate light



HOMOLOGATED

codice-code: LT002  
con copri faro - with cover

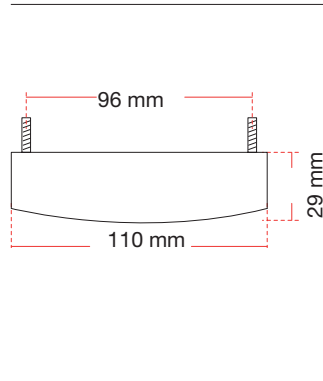

HOMOLOGATED

codice-code: LT003  
senza copri faro - without cover



HOMOLOGATED

E 4

codice-code: LT004

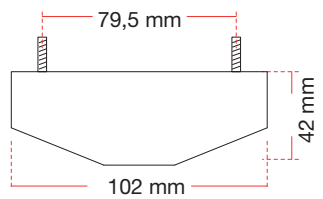

HOMOLOGATED

E 4

codice-code: LT005  
con supporto - with holder

### Piastrine frecce - Plate for direction indicators



codice-code: PFY

per 4 pezzi  
for 4 pieces



codice-code: PFK

per 4 pezzi  
for 4 pieces



codice-code: PFH2

per 4 pezzi  
for 4 pieces



codice-code: PFS

per 4 pezzi  
for 4 pieces

### Catadiottro con staffa di supporto - Retroreflector with support bracket

E 6

HOMOLOGATED



codice - code	nazione - nation	€
		a pezzo - for piece
KAT01	Italy - Spain - Portugal - Canada - USA - Australia - Deutschland	
KAT02	Switzerland - France	
KAT03	Slovenia	



**PROTEZIONI**  
PROTECTIONS

## Protezioni telaio

Frame sliders

**PATENTED**



DX = destro / right SX = sinistra / left Ø = foro interno boccola / internal bush hole

Colori disponibili: nero. Available colours: black

modello - model	anno - years		foro carena drill fairing	Ø	codice - code	€
	dal - from	al - to				
<b>APRILIA</b>						
APRILIA DORSODURO	08	12	NO	10	STEAP101	
APRILIA SHIVER 750	07	12	NO	10	STEAP101	
APRILIA TUONO V4	11	12	NO	10	STEAP103	
APRILIA RSV4 / factory	09	12	NO	-	STEAP102	
APRILIA RSV4 / factory	09	12	NO	-	STEAP104	
<b>BMW</b>						
BMW S1000RR	09	11	NO	10	STEBM101	
BMW S1000RR	12	12	NO	10	STEBM105	
BMW F800R	09	12	NO	-	STEBM102	
BMW R 1200 GS	08	12	NO	-	STEBM103	
<b>DUCATI</b>						
DUCATI HYPERMOTARD 1100	07	12	NO	10	STEDU101	
DUCATI HYPERMOTARD 796	09	12	NO	10	STEDU105	
DUCATI MONSTER 696 / 796	08	12	NO	10	STEDU102	
DUCATI STREETFIGHTER 1100	09	12	NO	10	STEDU103	
DUCATI MULTISTRADA 1200	10	12	NO	10	STEDU104	
<b>HONDA</b>						
HONDA CBR 600 RR	03	06	DX / SX	12	STEOH0101	
HONDA CBR 600 RR	07	08	NO	10	STEOH0102	
HONDA CBR 600 RR	09	12	DX / SX	12	STEOH0103	
HONDA CBR 600 F	11	12	DX / SX	12	STEOH0101	
HONDA HORNET 600	03	06	NO	10	STEOH0104	
HONDA HORNET 600	07	12	NO	12	STEOH0105	
HONDA HORNET 900	02	06	NO	10	STEOH0106	
HONDA CBR 1000	06	07	NO	10	STEOH0108	
HONDA CBR 1000	08	12	DX / SX	12	STEOH0109	
HONDA CBF 1000	06	12	NO	12	STEOH0110	
HONDA CB 1000 R	08	12	NO	12	STEOH0111	
HONDA VFR 800	02	06	NO	10	STEOH0112	
<b>HUSQVARNA</b>						
HUSQVARNA NUDA 900	12	12	NO	12	STEHU101	



modello - model	anno - years		foro carena drill fairing	Ø	codice - code	€
	dal - from	al - to				
<b>KAWASAKI</b>						
KAWASAKI 250R	09	12	NO	10	STEKA101	
KAWASAKI ZX6R	05	06	DX / SX	10	STEKA102	
KAWASAKI ZX6R	07	08	NO	10	STEKA103	
KAWASAKI ZX10R	08	10	SX	10	STEKA104	
KAWASAKI ZX10R	11	12	SX	10	STEKA110	
KAWASAKI Z750	04	06	NO	10	STEKA105	
KAWASAKI Z750	07	10	NO	10	STEKA106	
KAWASAKI Z1000	03	06	NO	10	STEKA105	
KAWASAKI Z1000	07	09	NO	10	STEKA106	
KAWASAKI Z1000	10	12	NO	10	STEKA107	
KAWASAKI ER - 6N	06	08	NO	10	STEKA108	
KAWASAKI ER - 6N	09	11	NO	10	STEKA109	
KAWASAKI ER - 6N	12	12	NO	10	STEKA111	
<b>KTM</b>						
KTM SUPER DUKE	05	06	NO	10	STEKT101	
KTM SUPER DUKE 990	07	12	NO	10	STEKT102	
<b>MV</b>						
MV BRUTALE 750 / 1000	01	12	NO	13	STEMV101	
<b>SUZUKI</b>						
SUZUKI GSXR 600 / 750	06	07	NO	10	STESU101	
SUZUKI GSXR 600 / 750	08	10	NO	10	STESU102	
SUZUKI GSXR 600 / 750	11	12	NO	10	STESU110	
SUZUKI GSXR 1000	03	04	NO	10	STESU103	
SUZUKI GSXR 1000	05	06	NO	10	STESU104	
SUZUKI GSXR 1000	07	08	NO	10	STESU105	
SUZUKI GSXR 1000	09	12	NO	10	STESU106	
SUZUKI SV 650 / 650S	04	08	NO	10	STESU107	
SUZUKI SV 1000	03	06	NO	10	STESU107	
SUZUKI GSR 600	06	11	NO	10	STESU108	
SUZUKI GSR 750	11	12	NO	10	STESU111	
SUZUKI Gladius 650	09	12	NO	10	STESU109	
<b>TRIUMPH</b>						
TRIUMPH Speed Triple 1050	05	07	NO	12	STETR101	
TRIUMPH Speed Triple 1050	08	10	NO	12	STETR102	
TRIUMPH Speed Triple 1050	11	12	NO	12	STETR104	
TRIUMPH Street Triple 675 / 675R	07	12	NO	10	STETR103	
<b>YAMAHA</b>						
YAMAHA R1	04	06	NO	10	STEYA101	
YAMAHA R1	07	08	NO	10	STEYA102	
YAMAHA R6	06	07	NO	10	STEYA103	
YAMAHA R6	08	12	NO	10	STEYA104	
YAMAHA FAZER 600 / FZ6	04	12	NO	10	STEYA105	
YAMAHA FZ8	10	12	NO	10	STEYA106	
YAMAHA FZ1	06	12	NO	10	STEYA106	
YAMAHA XJ6	09	12	NO	10	STEYA107	
YAMAHA MT-03	06	12	NO	10	STEYA108	



## Ricambi protezioni telaio

Frame slider spare parts



Colori disponibili: bianco, rosso, verde, nero, indaco  
Available colours: white, red, green, black, indigo

modello - model	Ø	codice - code	€
			a coppia - for pair
GOMMINO SHOCK ABSORBER SHOCK ABSORBER RUBBER	50mm	RSTE101	

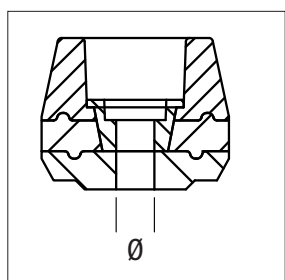

modello - model	codice - code	€
		a pezzo - for piece
BOCCOLE Ø10 - BUSHES Ø10	RSTE110	
BOCCOLE Ø12 - BUSHES Ø12	RSTE112	
BOCCOLE Ø13 - BUSHES Ø13	RSTE113	

## Protezione carter

Carter protector

**NEW**



modello - model	anno - years		codice - code	€
	dal - from	al - to		
<b>APRILIA</b>				
APRILIA RSV 4 + Factory	09	12	Copri alternatore lato L / electric cover L side Copri frizione lato R / clutch cover R side	ECP AP 001 ECP AP 002
<b>BMW</b>				
BMW S 1000 RR	09	12	Copri alternatore lato L / electric cover L side Copri pick up lato R / pick up cover R side	ECP BM 001 ECP BM 003
<b>DUCATI</b>				
DUCATI PANIGALE 1199	12	12	Copri alternatore lato L / electric cover L side Copri frizione lato R / clutch cover R side	ECP DU 001 ECP DU 002
<b>KAWASAKI</b>				
KAWASAKI ZX 10R	11	12	Copri alternatore lato L / electric cover L side Copri frizione lato R / clutch cover R side	ECP KA 001 ECP KA 002
<b>MV</b>				
MV AGUSTA F4	10	12	Copri alternatore lato L / electric cover L side Copri frizione lato R / clutch cover R side	ECP MV 001 ECP MV 002
<b>YAMAHA</b>				
YAMAHA R6	06	12	Copri alternatore lato L / electric cover L side Copri frizione lato R / clutch cover R side Copri pick up lato R / pick up cover R side	ECP YA 001 ECP YA 002 ECP YA 003

## Protezioni perni ruota

Wheel axle sliders



Colori disponibili: rosso, titanio - Available colours: red, titanium.

modello - model	anno - years		Ø		Ø		codice - code	€
	dal - from	al - to	ant. dx - right front	ant. sx - left front	post. dx - right rear	post. sx - left rear		
<b>APRILIA</b>								
APRILIA SHIVER 750	07	12	19	23	19	19	ARAP101	
APRILIA TUONO V4	11	12	19	23	19	19	ARAP101	
APRILIA RSV4 / Factory	09	12	20	24,9	20	20	ARAP101	
<b>BMW</b>								
BMW S1000RR	09	12	24	15,5	16	23	ARBM101	
<b>DUCATI</b>								
DUCATI 1199 PANIGALE	12	12	30	M25x1,25	N0	N0	ARDU101	
DUCATI DIAVEL	11	12	30	M25x1,25	N0	N0	ARDU101	
<b>HONDA</b>								
HONDA CBR 600 R	07	12	M14 x 1,50	17	14	19,6	ARHO101	
HONDA CBR 1000 R	08	12	M18 x 1,50	22	14	19,3	ARHO102	
<b>KAWASAKI</b>								
KAWASAKI ZX6R	07	12	22	22	19,5	14,5	ARKA101	
KAWASAKI ZX10R	06	07	19,3	15,6	14,6	10,6	ARKA102	
KAWASAKI ZX10R	08	10	22	22	14	10	ARKA103	
KAWASAKI ZX10R	11	12	22	22	19,5	14,5	ARKA101	
KAWASAKI Z 1000	07	09	22	22	15,6	14,5	ARKA104	
<b>SUZUKI</b>								
SUZUKI GSXR 600 / 750	06	10	M18 x 1,50	24	16,5	23,2	ARSU101	
SUZUKI GSXR 600 / 750	11	12	19	11,8	19	14	ARSU102	
SUZUKI GSXR 1000	07	12	M18 x 1,50	24	16,5	23,2	ARSU101	
<b>YAMAHA</b>								
YAMAHA R6	06	12	19	M14 x 1,5	16	23,5	ARYA101	
YAMAHA R1	07	12	19	M14 x 1,5	16	23,5	ARYA101	

## Tappi telaio

Frame cups



Colori disponibili: rosso, oro, nero, silver. Available colours: red, gold, black, silver.

codice - code	Ø interno - inside	Ø esterno - outside	€
			a pezzo - for piece
CFT2026	20 mm	26 mm	
CFT2228	22 mm	28 mm	
CFT2530	25 mm	30 mm	
CFT2331	23 mm	31 mm	









**VITERIA  
SCREWS**











## Viti special in ergal 7075 - 7075 ergal special screws

Viti special - standard - special screws - standard

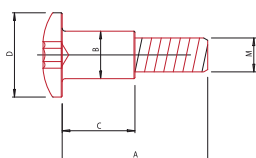

936

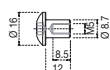

1011

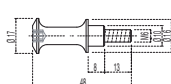

1012

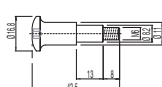

1014

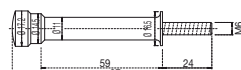

1024

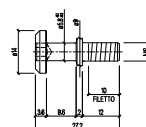
silver  
silverblu  
blueindaco  
indigonero  
blackoro  
goldrosso  
redColori disponibili:  
Available colours:

codice - code	M	A	B	C	D	€
930	8	38,5	12,4	19	22	
931	10	49	12,4	18,5	22	
931B	10	38	12,4	19	22	
932	4	12			9	
933	6	19,5	7,5	3,5	14	
934	10	56,5	11,9	22,5	19	
935	8	38,5	11,9	22,5	19	
936	5	12	8,7	12	16	
940	6	17,4	7,9	8,4	17	
941	5	15	7,4	7,5	12	
950	6	20			10	
951	8	31	10	6	17	
952	8	41	9,9	6	16	
953	8	20	9,9	5	17	
954	6	30	6	9	10	
955	6	23,5	9,9	11	20	
956	6	15			10	
960	8	33	9,9	11	15	
961	10	25	9,9	4	15	
962	5	16,5	8,1	3,7	14	

codice - code	M	A	B	C	D	€
963	6	20	7,9	9,5	18	
964	7	17,5	10,9	5,5	24	
965	6	15	7,9	3	14	
970	4	21,5	4	5,5	10	
971	4	7			10	
972	6	11,5	8,2	3,75	14	
974	6	15	9,85	5	22	
976	6	19	7,9	8	14	
977	6	30,5	8	23,5	14	
978	6	15	7,9	6	14	
979	6	13	6,9	4,4	14	
980	6	14	7,9	3,8	14	
981	5	15,6	7,9	2,6	14	
982	6	16	8,4	3,5	14	
983	6	15	7,9	6	17	
984	6	15	8,9	4	14	
991	6	30	6	11	12	
992	6	11	9,9	3,5	17	
993	5	10	8,9	3	14	
994	6	14,5	9,4	6	17	
995	6	14,5	11,9	3,5	17	
997	6	15	8,9	5	14	
998	6	15	9,9	3,5	17	
999	5	15	7	2,5	11,5	
1000	6	15	9	2	14	
1001	5	20,5	7	13,5	12	
1002	5	20,5	6,9	2,5	12	
1003	6	11	8,2	4	14	
1004	6	14	7,9	5,5	14	
1005	6	15	9,8	5,5	22	
1006	10	40	10	5	16	
1007	6	20	6	1,5	30	
1008	6	25,5	8	13,5	17	
1009	5	25			9	
1011	6	21	10	8	17	
1012	6	21	8,25	13	17	
1013	6	25,5	8	10,5	24	
1014	modifica chiusura sella triumph - special screw to open and close the triumph seat					
1015	5	16	8,2	8	14	
1016	6	16,5	8,5	3,5	17	
1018	6	16,5	8,2	5	12	
1019	6	20	9,8	8,6	17	
1020	5	17	8,2	5,8	14	
1021	6	20	8,7	9,2	14	
1022	5	12,8	8,1	3,7	14	
1023	5	11	8	2,6	14	
1024	6	-	-	-	-	
1025						
1026						
1027						
1028						

# Viteria

## Screws



silver  
silver



blu  
blue



indaco  
indigo



nero  
black



oro  
gold



rosso  
red

Colori disponibili:  
Available colours:

### Viti forate - Drilled screws

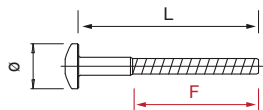

	lunghezza - length	ø testa - head	codice - code	€
M5	15	12	FORM515	
M5	20	12	FORM520	
M6	15	17	FORM615	
M6	20	17	FORM620	
M6	25	17	FORM625	
M6	30	17	FORM630	
M8	20	22	FORM820	
M8	30	22	FORM830	
M8	40	22	FORM840	
M8	45	22	FORM845	

### Ergal 7075 / Autofilettanti - Self tapping screws



PAC 2

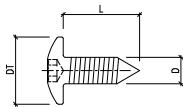

ø	lunghezza - length	ø testa - head	codice - code	€
4,5	13	10	PAC24513	
4,5	16	10	PAC24516	
4,9	13	10	PAC24913	
4,9	16	10	PAC24916	
5,5	16	10	PAC25516	
5,5	19	10	PAC25519	



PAC 3

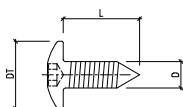

4,5	13	14	PAC34513	
4,5	16	14	PAC34516	
4,9	13	14	PAC34913	
4,9	16	14	PAC34916	
5,5	16	14	PAC35516	
5,5	19	14	PAC35519	

### Ergal 7075 / Ganci rapidi - Quick fairing fasteners

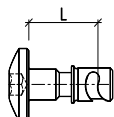



misura - measure	codice - code	€
11 mm	GR11	
12 mm	GR12	
14 mm	GR14	
16 mm	GR16	
22 mm	GR22	

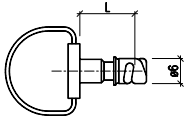

Ganci rapidi in acciaio - Steel quick fairing fasteners		misura - measure	codice - code	€
		11 mm	GRSTTB11	
		12 mm	GRSTTB12	
		14 mm	GRSTTB14	

Ganci rapidi in ferro - Iron quick fairing fasteners			€	
		11 mm	GRFE11	
		12 mm	GPFE12	
		14 mm	GRFE14	

Ricettacoli - Receptacle		codice - code	€
		RIC	

Cappelletto valvola ruota - Wheel valve cap		codice - code	€
		VAL	

Colori disponibili:  
Available colours:

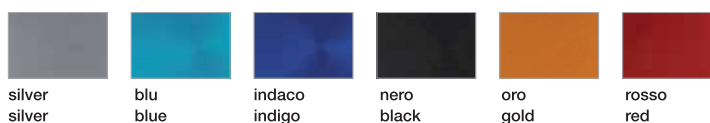

## Dadi e Rondelle in Ergal

### Ergal Nuts and Washers

Colori disponibili:  
Available colours:



silver  
silver



blu  
blue



indaco  
indigo



nero  
black



oro  
gold



rosso  
red



	M4	M5	M6	M8	M10 x 1,25	M10 x 1,5	M12 x 1,25
<b>0011</b>							
€							



	M4	M5	M6	M8	M10 x 1	M10 x 1,5	M12 x 1,25
<b>0012</b>							
€	-	-	-	-		-	-



	M4	M5	M6	M8	M10 x 1,25	M10 x 1,5	M12 x 1,25
<b>0015</b>							
€					-	-	-



	M4	M5	M6	M8	M10 x 1,25	M10 x 1,5	M12 x 1,25
<b>0016</b>							
€	-				-	-	-



Standard

misura - measure	Ø est. Ø ext.	spessore - thickness	codice - code	€
M4	9	0,8	RM4	
M5	10	1,5	RM5	
M6	12	1,6	RM6	
M8	17	1,6	RM8	
M10	21	2	RM10	



Special

misura - measure	Ø est. Ø ext.	spessore - thickness	codice - code	€
M5	17	1,6	RSM5A	
M6	17	1,6	RSM6A	
M6	21	1,6	RSM6B	
M8	21	2	RSM8A	
M10	30	2	RSM10	



T0015	M4	M5	M6	M8	M10 x 1,25	M10 x 1,5	M12 x 1,25
€							



misura - measure	Ø est. Ø ext.	spessore - thickness	codice - code	€
M4	9	0,8	RM4T	
M5	10	1,5	RM5T	
M6	12	1,6	RM6T	
M8	17	1,6	RM8T	
M10	21	2	RM10T	



misura - measure	Ø est. Ø ext.	spessore - thickness	codice - code	€
M5	17	1,6	RSM5AT	
M6	17	1,6	RSM6AT	
M6	21	1,6	RSM6BT	
M8	21	2	RSM8AT	
M10	30	2	RSM10T	

## RONDELLE IN NYLON - NYLON WASHERS



misura - measure	Ø est. Ø ext.	spessore - thickness	codice - code	€
M4	10	0,5	RPM4	
M5	12	0,5	RPM5	
M6	14	0,5	RPM6	
M8	16	0,5	RPM8	

## Viti dischi freno in titanio grado 5

Screws for brake disk in titanium 5 degree



I modelli di moto citati sono indicativi,  
pertanto si consiglia di verificare le misure delle viti.

The motorbikes mentioned can be not correct,  
please control the measures.

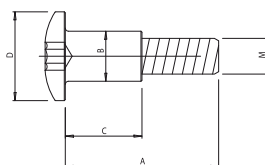

moto - bike	M	A	B	C	D	codice - code	€
							a pezzo - for piece
KAWASAKI	8	31	10	5	18	VIT K	
SUZUKI	8	33	10	10	16	VIT S	
SUZUKI	8	21	9,9	6	16	VIT S2	
DUCATI	8	15	-	-	13	VIT D1	
DUCATI	8	20	-	-	13	VIT D2	
HONDA ANT. / front	6	20	-	-	15	VIT H1	
HONDA POST. / rear	8	23	10	5	16	VIT H2	
HONDA CR. ANT. / front	8	20	-	-	12	VIT H3	
YAMAHA ANT. / front	6	21	8	6	14	VIT Y	
YAMAHA POST. / rear	8	20	9,8	4,5	16	VIT Y2	

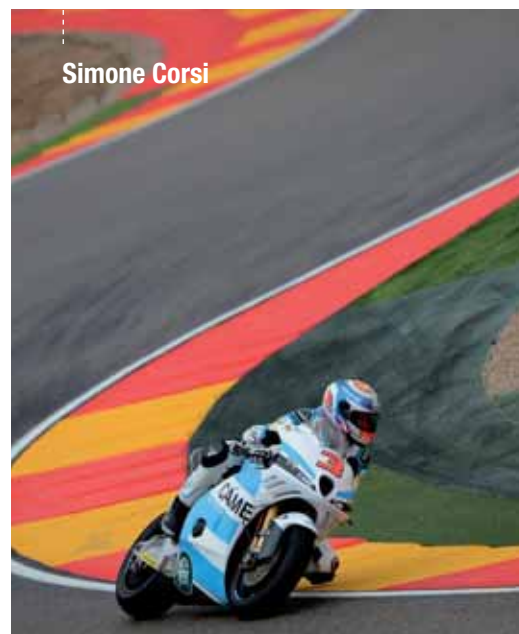





**KIT VITI**  
**SCREW KIT**

## Kit viti

Screw kit



modello - model	anno - years		MOTORE / ENGINE			TELAIO / FRAME		
	dal - from	al - to	quantità pieces	codice code	€	quantità pieces	codice code	€
<b>APRILIA</b>								
APRILIA TUONO V4	11	12	34	1AT M		28	1AT T	
APRILIA RSV 1000	04	04	55	4A1 M		33	4A1 T	
APRILIA RSV 1000 R	05	08	56	5A1 M		33	5A1 T	
APRILIA RSV 4 R+ Factory + APRC	09	12	30	9A4 M		22	9A4 T	
APRILIA DORSODURO 750	08	12	24	9AD M		29	9AD T	
APRILIA DORSODURO 1200	11	12	26	1AD M		25	1AD T	
APRILIA SHIVER	07	12	38	7A7 M		27	7A7 T	
APRILIA TUONO 1000	03	05	31	3A1 M		30	3A1 T	
APRILIA TUONO 1000	06	09						
<b>BMW</b>								
BMW S 1000 RR	09	12	38	0B1 M		23	0B1 T	
BMW F800R	10	12	39	0B8 M		25	0B8 T	
BMW R 1200 GS	08	12	4	1BG H				
<b>BENELLI</b>								
TNT	04		26	4B1 M		33	4B1 T	
<b>DUCATI</b>								
DUCATI MONSTER 900	99	01	68	KD9 M		47	KD9 T	
DUCATI MONSTER 600 / 750	99	01	53	KD699 M		43	KD699 T	
DUCATI MONSTER DARK IE 620	02	07	54	3DD M		48	3DD T	
DUCATI MONSTER S4R	03	04	65	3DS M		35	3DS T	
DUCATI MONSTER 696	08	12	42	8D6 M		14	8D6 T	
DUCATI 748 - 916 - 996	96	01	81	KD7 M		93	KD7 T	
DUCATI 749 -999	02	06	48	2D9 M		33	2D9 T	
DUCATI DS 1000 MULTISTRADA	03	09	57	3D1 M		25	3D1 T	
DUCATI DS 1200 MULTISTRADA	10	12	34	0D1 M		23	0D1 T	
DUCATI 1098 - 1198	07	11	26	7D1M		20	7D1 T	
DUCATI 848	08	12	24	8D8 M		16	8D8 T	
DUCATI HYPERMOTARD 1100	07	12	34	7DM M		24	7DM T	
DUCATI STREETFIGHTER 1100	09	12	47	9DS M		13	9DS T	
DUCATI DIAVEL	11	12	35	2DD M		23	2DD T	
DUCATI 1199 Panigale	12	12	24	2DP M		24	2DP T	
<b>HONDA</b>								
HONDA INTEGRA	12	12				11	2H1T	
HONDA HORNET 600	03	06	41	2H6 M		30	2H6 T	
HONDA HORNET 600	07	10	26	7HH M		27	7HH T	
HONDA HORNET 600	11	12	26	1HH M		25	1HH T	
HONDA CBR 600 RR	03	04	35	3H6 M		23	3H6 T	
HONDA CBR 250 RR	11	12	24	2H5 M		20	2H5 T	
HONDA CBR 600 RR	05	06	35	5H6 M		25	5H6 T	
HONDA CBR 600 RR	07	08	25	7H6 M		27	7H6 T	
HONDA CBR 600 RR	09	10				30	9HC T	
HONDA CBR 600 F	11	12	21	1H6 M		25	1H6 T	
HONDA CBR RR 954	02	03	23	2H9 M		24	2H9 T	
HONDA CBR 1000 RR	04	05	30	4H1 M		24	4H1 T	
HONDA CBR 1000 RR	06	07	30	6H1 M		24	6H1 T	
HONDA CBR 1000 RR	08	12	26	8H1 M		26	8H1 T	
HONDA CB 1000 R	08	12	25	8HB M		32	8HB T	
HONDA CRF 450	05	07	37	5H4 M		17	5H4 T	
HONDA CRF 450	08	09	37	8H4 M		17	8H4 T	
HONDA CRF 450	10	11	39	0H4M		6	0H4T	









## Kit viti

Screw kit



modello - model	anno - years		MOTORE / ENGINE			TELAIO / FRAME		
	dal - from	al - to	quantità pieces	codice code	€	quantità pieces	codice code	€
<b>TRIUMPH</b>								
TRIUMPH SPEED TRIPLE 955	02	04	60	2TT M		25	2TT T	
TRIUMPH SPEED TRIPLE 1050	05	07	57	5TT M		25	5TT T	
TRIUMPH SPEED TRIPLE 1050	08	10	55	8TT M		24	8TT T	
TRIUMPH SPEED TRIPLE 1050	11	12	52	0TT M		33	0TT T	
TRIUMPH DAYTONA 675	07	12	33	7TD M		34	7TD T	
TRIUMPH STREET TRIPLE 675 / 675 R	07	12	36	7T6 M		29	7T6 T	
<b>YAMAHA</b>								
YAMAHA T MAX	04	07	16	4YT M				
YAMAHA T MAX	08	11	17	8YT M				
YAMAHA T MAX	12	12				16	2YXT	
YAMAHA FAZER 600 + FZ6 600	04	12	40	4Y6 M		24	4Y6 T	
YAMAHA FAZER 1000	01	05	32	1YF M				
YAMAHA FZ1	06	12	35	6Y1 M		22	6Y1 T	
YAMAHA FZ8	10	12	28	0Y8 M		28	0Y8 T	
YAMAHA R6	03	04	38	3Y8 M		27	3Y8 T	
YAMAHA R6	05	05	38	5Y6 M		26	5Y6 T	
YAMAHA R6	06	07	32	6Y6 M		28	6Y6 T	
YAMAHA R6	08	12	32	8Y6 M		22	8Y6 T	
YAMAHA R1	02	03	29	2Y1 M		27	2Y1 T	
YAMAHA R1	04	06	26	4Y1 M		28	4Y1 T	
YAMAHA R1	07	08	33	7Y1 M		33	7Y1 T	
YAMAHA R1	09	12	33	9Y1 M		23	9Y1 T	
YAMAHA XJ6	08	12	28	8YJ M		18	8YJ T	
YAMAHA MT - 03	06	12	30	6YM M		25	6YM T	



CARENA / FAIRING			GANCI RAPIDI / QUICK FASTENERS			CUPOLINO / WINDSCREEN			TAPPO SERBATOIO / FUEL TANK CAP	
quantità pieces	codice code	€	quantità pieces	codice code	€	quantità pieces	codice code	€	codice code	€
47	2TT C									
44	5TT C									
37	8TT C									
48	0TT C								KTYB	
46	7TD C					8	KC006		KTYB	
33	7T6 C								KTYB	
48	4YT C									
43	8YT C									
43	2TXC									
38	4Y6 C					6	KC049		KTYT	
81	1YF C					8	KC033		KTY5	
58	6Y1 C								KTYT	
51	0Y8 C					2	KC061		KTYT	
70	3Y8 C					4	KC015		KTYT	
76	5Y6 C					4	KC015		KTYT	
60	6Y6 C					4	KC015		KTYT	
54	8Y6 C					4	KC015		KTYT	
51	2Y1 C		14	2Y1 GR		6	KC013			
62	4Y1 C		18	4Y1 GR		6	KC013		KTYT	
52	7Y1 C		12	7Y1 GR					KTYT	
52	9Y1 C		14	9Y1 GR					KTYT	
48	8YJ C								KTYT	
44	6YM C									



**Starter kit viti**

Starter screw kit

**NEW**

modello - model	quantità - pieces	codice - code	€
-----------------	-------------------	---------------	---

**STARTER KIT**

Solo viteria - 2 colori / Only bolts and screw - 2 colours

305

KIT001

Solo viteria - 3 colori / Only bolts and screw - 3 colours

457

KIT002

DISTINTA BASE - LIST	codice - code	KIT001 quantità - pieces	KIT002 quantità - pieces
----------------------	---------------	-----------------------------	-----------------------------

002M4015	12	18
002M5015	12	18
002M5020	12	18
002M6015	12	18
002M6025	12	18
003M6015	12	18
003M6020	12	18
003M6030	12	18
001M5015	12	18
001M5020	12	18
001M6020	12	18
001M6025	12	18
001M6030	12	18
001M8030	12	18
004M6015	12	18
004M6020	12	18
004M6030	12	18
004M6040	12	18
004M8035	12	18
0011M04	12	18
0011M05	12	18
0011M06	12	18
0011M08	10	15
RPM4	10	15
RPM5	10	15
RPM6	10	15
BOX	1	1
<b>Totale - Total</b>	<b>305</b>	<b>457</b>





**DADI  
SPECIALI  
SPECIAL  
NUTS**

## Dadi speciali ergal 7075

7075 ergal special nuts



Colori disponibili:  
Available colours:

silver  
silver

blu  
blue

indaco  
indigo

nero  
black

oro  
gold

rosso  
red

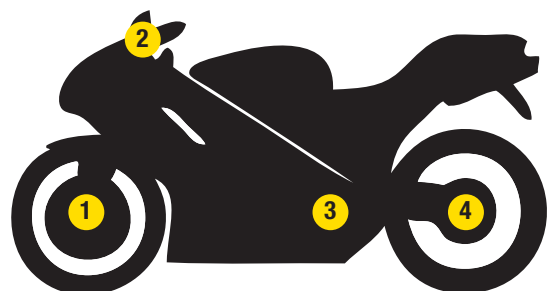

### POSIZIONE - POSITION

- 1** Perno ruota anteriore / Front wheel axle
- 2** Canotto sterzo / Steering stem head
- 3** Perno forcellone / Swing arm pivot shaft
- 4** Perno ruota posteriore / Rear wheel axle

modello - model	anno - years		posizione - position <b>1</b>		posizione - position <b>2</b>		posizione - position <b>3</b>		posizione - position <b>4</b>	
	dal - from	al - to	codice - code	€	codice - code	€	codice - code	€	codice - code	€
<b>APRILIA</b>										
APRILIA RSV 1000	04	05	D001		-		D010		D001	
APRILIA RSV4 / Factory	09	12	D001		-		D010		D001	
APRILIA Tuono	06	09	-		-		D010		D001	
APRILIA Tuono V4	11	12	D001		-		D010		D001	
APRILIA Dorsoduro 750	08	12	D001		-		D010		D001	
APRILIA Dorsoduro 1200	11	12	D001		-		D010		D001	
APRILIA SHIVER 750	07	12	D001		-		D010		D001	
<b>BMW</b>										
BMW S1000RR	09	12	-		D014		D004		D003	
BMW F800R	10	10	-		-		-		D011	
<b>DUCATI</b>										
DUCATI Monster / 610 ie	03	07	D019		-		-		-	
DUCATI 748/916/996/998	96	01	D019		-		-		D008 right	
									D009 left	
DUCATI 848	08	12	-		-		-		D020 right	
									D009 left	
DUCATI Hypermotard 1100	07	12	D019		-		-		D008 right	
									D009 left	



modello - model	anno - years		posizione - position 1		posizione - position 2		posizione - position 3		posizione - position 4	
	dal - from	al - to	codice - code	€	codice - code	€	codice - code	€	codice - code	€
<b>HONDA</b>										
HONDA CBR 250	11	12	-		-		-		D011	
HONDA CBR 600 RR	05	06	-		D006		-		D018	
HONDA CBR 600 RR	07	12	-		D006		D004		D018	
HONDA CBR 1000 RR	04	07	-		-		D018		D018	
HONDA CBR 1000 RR	08	12	-		D022		D018		D018	
HONDA CB 1000 R	08	12	-		D006		D004		D023	
HONDA HORNET 600	03	06	-		D006		D007		D011	
HONDA HORNET 600	07	12	-		D006		D004		D004	
HONDA HORNET 900	02	08	-		D006		-		D004	
HONDA CBR 600 F	11	12	-		D006		D004		D004	
HONDA INTEGRA	12	12	-		-		-		D004	
<b>HUSQVARNA</b>										
HUSQVARNA NUDA 900	12	12	-		-		D007		D011	
<b>KAWASAKI</b>										
KAWASAKI 250R	09	12	D007		-		-		D011	
KAWASAKI ZX6R	03	04	-		D002		D010		D003	
KAWASAKI ZX6R	05	06	-		D014		D010		D003	
KAWASAKI ZX6R	07	08	-		D014		D010		D003	
KAWASAKI ZX6R	09	12	-		D014		D010		D003	
KAWASAKI ZX10R	04	05	-		D014		D010		D004	
KAWASAKI ZX10 R	06	07	-		D014		D010		D004	
KAWASAKI ZX10 R	08	10	-		-		D010		D004	
KAWASAKI ZX10 R	11	12	-		D014		D010		D013	
KAWASAKI ER - 6N	06	08	-		-		-		D004	
KAWASAKI ER - 6N	09	11	-		-		D010		D004	
KAWASAKI ER - 6N	12	12	-		-		-		D004	
KAWASAKI Z 750	04	06	-		D002		D010		D004	
KAWASAKI Z 750	07	12	-		-		D010		D004	
KAWASAKI Z 1000	03	06	-		-		D010		D003	
KAWASAKI Z 1000	07	09	-		-		D010		D003	
KAWASAKI Z 1000 / Z1000 SX	10	12	-		-		D010		-	
<b>MV</b>										
MV AGUSTA F3 675	12	12	D019		-		-		-	
MV AGUSTA BRUTALE 675	12	12	D019		-		-		-	
MV AGUSTA F4	00	09								
MV AGUSTA F4	10	12								
<b>SUZUKI</b>										
SUZUKI GSXR 1000	05	12	-		D014		D010		D001	
SUZUKI GSXR 600 / 750	06	10	-		D014		D010		D001	
SUZUKI GSXR 600 / 750	11	12	D010		D014		D010		D018	
SUZUKI GSR 600	06	11	-		D013		D010		D018	
SUZUKI GSR 750	11	12	-		-		-		D018	
SUZUKI SV 650 / 650S	03	08	-		D013		D004		D004	
SUZUKI GLADIUS	09	12	-		D005		-		D010	
<b>TRIUMPH</b>										
TRIUMPH Speed Triple 1050 / 1050R	08	12	-		-		-		D020 right	
									D021 left	
TRIUMPH Street Triple 675 / 675R	07	12	-		D002		D011		D004	
TRIUMPH DAYTONA 675 / 675R	07	12	-		D002		D011		D004	
<b>YAMAHA</b>										
YAMAHA R6	06	12	-		D014		D018		D003	
YAMAHA R1	04	06	-		D014		D004		D003	
YAMAHA R1	07	12	-		D014		D010		D003	
YAMAHA MT-03	06	11	-		D005		D011		D011	
YAMAHA Fazer 600 / FZ6	04	12	-		D005		D004		D003	
YAMAHA XJ6	08	12	-		D005		D007		D011	
YAMAHA FZ1 / FAZER 1000	06	12	-		D014		D004		D003	
YAMAHA FZ8	10	12	-		D014		D004		D003	
YAMAHA T-MAX 530	12	12	-		-		-		D013	



Andrea Dovizioso



Cal Crutchlow



Eric Granado



Johann Zarco





**TAPPI**  
CAPS

## Tappi serbatoio attacco rapido

Fuel tank caps with rapid locking



Colori disponibili:  
Available colours:

silver  
silver

blu  
blue

indaco  
indigo

nero  
black

oro  
gold

rosso  
red



Model TR9



Model TR6



Model TR4



Model TR5

modello - model	anno - years		codice - code	€
	dal - from	al - to		
APRILIA			TR5	
APRILIA RSV 1000	04	08	TR10	
APRILIA RSV4 Factory	09	12	TR10	
APRILIA TUONO V4	11	12	TR10	
BMW S 1000 RR	09	12	TR11	
DUCATI			TR1	
DUCATI 749 - 999	02	06	TR7	
DUCATI DS 1000 Multistrada	03	09	TR7	
DUCATI STREETFIGHTER	09	12	TR10	
DUCATI 1199 Panigale	12	12	TR12	
GUZZI			TR5	
HONDA			TR2	
KAWASAKI			TR4	
KAWASAKI ER - 6N	12	12	TR9	
KAWASAKI ZX 6 R	07	12	TR9	
KAWASAKI ZX 10 R	06	12	TR9	
KAWASAKI Z 1000 / Z 1000SX	10	12	TR9	
MV AGUSTA F4 / BRUTALE	97	09	TR1	
SUZUKI			TR3	
SUZUKI GSXR 1000	03	12	TR6	
SUZUKI GSXR 600 / 750	04	12	TR6	
SUZUKI GSR 600	06	11	TR6	
SUZUKI GSR 750	11	12	TR6	
TRIUMPH			TR5	
TRIUMPH SPEED TRIPLE 1050	11	12	TR14	
YAMAHA			TR1	



Model TR7



Model TR3

### Ricambio Flangia interna - Internal spare part



Model TRF

Colori disponibili: nero  
Available colours: black

codice - code

€

TRF

## Tappi serbatoio attacco a vite

Fuel tank caps with spin locking



Colori disponibili:  
Available colours:

silver  
silver

blu  
blue

indaco  
indigo

nero  
black

oro  
gold

rosso  
red



Model TF1 / TF2



Model TF4



Model TF10 / TF11 / TF12



Model TF13

modello - model	anno - years		codice - code	€
	dal - from	al - to		
APRILIA			TF5	
APRILIA RSV4 Factory	09	11	TF10	
APRILIA RSV 1000	04	08	TF10	
APRILIA TUONO V4	11	12	TF10	
BMW S1000 RR	09	12	TF11	
DUCATI			TF1	
DUCATI Streetfighter	09	12	TF10	
DUCATI 1199 Panigale	12	12	TF12	
DUCATI Diavel	11	12	TF13	
GUZZI			TF5	
HONDA			TF2	
KAWASAKI			TF4	
KAWASAKI ER - 6N	12	12	TF9	
KAWASAKI ZX6R	07	12	TF9	
KAWASAKI ZX10 R	06	12	TF9	
KAWASAKI Z 1000 / Z1000 SX	11	12	TF9	
MV AGUSTA F4 / BRUTALE	97	09	TF1	
SUZUKI GSXR 1000	03	12	TF6	
SUZUKI GSXR 600 / 750	04	12	TF6	
SUZUKI GSR 600	06	11	TF6	
SUZUKI GSR 750	11	12	TF6	
TRIUMPH			TF5	
YAMAHA			TF1	

### Ricambio Flangia interna - Internal spare part



Colori disponibili: nero  
Available colours: black

codice - code	€
TFC	

### Chiave racing - Racing key



codice - code	€
TFT	



## Tappi olio

Oil filler caps



Colori disponibili:  
Available colours:

silver  
silver

blu  
blue

indaco  
indigo

nero  
black

oro  
gold

rosso  
red



modello - model	misura - measure	codice - code	€
APRILIA TUONO	M 20 X 1,5	OIL 001	
APRILIA TUONO V4	M 25 X 1,5	OIL 002	
APRILIA SHIVER	M 25 X 1,5	OIL 002	
APRILIA DORSODURO	M 25 X 1,5	OIL 002	
APRILIA RSV 4 + factory	M 25 X 1,5	OIL 002	
BMW S1000 RR	M 24 X 2	OIL 007	
BMW R 1200 GS	M 34 x 1,5	OIL 008	
CAGIVA RAPTOR	M 20 X 1,5	OIL 001	
DUCATI	M 22 X 1,5	OIL 003	
DUCATI 848 / Panigale	M 20 X 2,5	OIL 004	
DUCATI MONSTER 696	M 20 X 2,5	OIL 004	
GUZZI GRISO	M 20 X 1,5	OIL 001	
HONDA	M 20 X 2,5	OIL 004	
KAWASAKI	M 30 X 1,5	OIL 005	
KAWASAKI ER 6N	M 20 X 2,5	OIL 004	
KAWASAKI Z 1000 + SX	M 20 X 2,5	OIL 004	
MV AGUSTA F3	M 25 X 1,5	OIL 009	
SUZUKI	M 20 X 1,5	OIL 001	
TRIUMPH	M 20 X 2,5	OIL 004	
YAMAHA	M 26 X 3	OIL 006	
YAMAHA MT 03	M 20 X 2,5	OIL 004	
YAMAHA T-MAX	M 20 X 2,5	OIL 004	

## Chiave racing - Racing key



codice - code	€
TFT	



# Tappi olio

Oil filler caps

Colori disponibili:  
Available colours:



silver  
silver



blu  
blue



indaco  
indigo



nero  
black



oro  
gold



rosso  
red



modello - model	misura - measure	codice - code	€
APRILIA TUONO	M 20 X 1,5	OILS	
APRILIA TUONO V4	M 25 X 1,5	OILA	
APRILIA SHIVER	M 25 X 1,5	OILA	
APRILIA DORSODURO	M 25 X 1,5	OILA	
APRILIA RSV 4 + factory	M 25 X 1,5	OILA	
BENELLI	M 24 X 1,5	OILB	
BMW S1000 RR	M 24 X 2	OILBM01	
CAGIVA RAPTOR	M 20 X 1,5	OILS	
DUCATI	M 22 X 1,5	OILD	
DUCATI 848 / Panigale	M 20 X 2,5	OILH	
DUCATI MONSTER 696	M 20 X 2,5	OILH	
GUZZI GRISO	M 20 X 1,5	OILS	
HONDA	M 20 X 2,5	OILH	
KAWASAKI	M 30 X 1,5	OILK2	
KAWASAKI ER 6N	M 20 X 2,5	OILH	
KAWASAKI Z 1000	M 20 X 2,5	OILH	
MINARELLI	M 14 X 1,5	OILM	
MORINI CORSARO	M 24 X 1,5	OILB	
MV AGUSTA	M 25 X 1,5	OILMV	
SUZUKI	M 20 X 1,5	OILS	
TRIUMPH	M 20 X 2,5	OILH	
YAMAHA	M 26 X 3	OILY	
YAMAHA MT 03	M 20 X 2,5	OILH	
YAMAHA T-MAX	M 20 X 2,5	OILH	



**FINO A ESAURIMENTO - TO EXHAUSTION**

modello - model	misura - measure	codice - code	€
APRILIA TUONO	M 20 X 1,5	OILSW	
BMW S1000 RR	M 24 X 2	OILBM01W	
DUCATI	M 22 X 1,5	OILDW	
DUCATI 848 / Panigale	M 20 X 2,5	OILHW	
DUCATI MONSTER 696	M 20 X 2,5	OILHW	
GUZZI GRISO	M 20 X 1,5	OILSW	
HONDA	M 20 X 2,5	OILHW	
KAWASAKI	M 30 X 1,5	OILK2W	
KAWASAKI ER 6N / Z 1000 SX	M 20 X 2,5	OILHW	
SUZUKI	M 20 X 1,5	OILSW	
TRIUMPH	M 20 X 2,5	OILHW	
YAMAHA	M 26 X 3	OILYW	
YAMAHA MT 03	M 20 X 2,5	OILHW	
YAMAHA T-MAX	M 20 X 2,5	OILHW	

## Coperchi pompe freno e frizione

Clutch/brake pump reservoir covers



silver  
silver



blu  
blue



indaco  
indigo



nero  
black



oro  
gold



rosso  
red

Colori disponibili:  
Available colours:

modello - model	anno - years		codice - code		€
	dal - from	al - to			
<b>APRILIA</b>					
APRILIA SHIVER 750	07	12	freno post / rear brake	FFC05	
APRILIA DORSODURO 750	09	12	freno ant / front brake	FBC17	
			freno post / rear brake	FFC05	
			frizione / clutch	FFC06	
APRILIA RSV 4 + Factory	09	12	freno ant / front brake	FBC14	
APRILIA TUONO V4	11	12	freno ant / front brake	FBC14	
<b>BMW</b>					
BMW S 1000 RR	09	12	freno ant / front brake	FBC06	
BMW R 1200 GS	08	12	freno ant / front brake	FBC20	
			frizione / clutch	FFC08	
<b>DUCATI</b>					
DUCATI STREETFIGHTER	09	12	freno ant / front brake	FBC18	
			freno post / rear brake	FFC03	
			frizione / clutch	FFC07	
DUCATI MONSTER 696-796	08	12	freno ant / front brake	FBC07	
			freno post / rear brake	FFC03	
			frizione / clutch	FFC04	
DUCATI HYPERMOTARD 1100	07	10	freno ant / front brake	FBC04	
			freno post / rear brake	FFC03	
			frizione / clutch	FFC03	
DUCATI 848	08	12	freno ant / front brake	FBC04	
			freno post / rear brake	FFC03	
			frizione / clutch	FFC03	
DUCATI 749-999	02	06	freno ant / front brake	FBC08	
			frizione / clutch	FFC02	
DUCATI 1098/1198	07	11	freno ant / front brake	FBC04	
			freno post / rear brake	FFC03	
			frizione / clutch	FFC03	
DUCATI DIAVEL (rosso, nero e silver - red, black and silver)	11	12	freno ant / front brake	FBC21	
			frizione / clutch	FFC09	
DUCATI Panigale	12	12	freno ant / front brake	FBC04	
			freno post / rear brake	FFC03	
			frizione / clutch	FFC03	
<b>HONDA</b>					
HONDA CBR 1000 RR	04	05	freno ant / front brake	FBC14	
HONDA CBR 1000 RR	06	12	freno ant / front brake	FBC06	
HONDA CBR 600 RR	03	06	freno ant / front brake	FBC01	
HONDA CBR 600 RR	07	12	freno ant / front brake	FBC06	
HONDA HORNET 600	03	06	freno ant / front brake	FBC01	
HONDA HORNET 600	11	12	freno ant / front brake	FBC01	
HONDA CB 1000 R	08	12	freno ant / front brake	FBC06	
			freno post / rear brake	FBC06	
			frizione / clutch	FFC05	
HONDA HORNET 900	02	07	freno ant / front brake	FBC01	

## Coperchi pompe freno e frizione

### Clutch/brake pump reservoir covers



modello - model	anno - years		codice - code		€
	dal - from	al - to			
<b>HUSQVARNA</b>					
HUSQVARNA 900 NUDA*	12	12	freno ant / front brake	FBC04*	
* necessita di due viti 005-M5x45 / two screws 005-M5x45 required					
<b>KAWASAKI</b>					
KAWASAKI 250R	09	12	freno post / rear brake	FBC06	
KAWASAKI ZX6R	07	08	freno ant / front brake	FBC06	
			freno post / rear brake	FFC05	
KAWASAKI ZX6R	09	12	freno ant / front brake	FBC06	
KAWASAKI Z750 / Z1000	03	06	freno ant / front brake	FBC02	
KAWASAKI Z750	07	12	freno ant / front brake	FBC06	
KAWASAKI Z750 R	11	12	freno ant / front brake	FBC19	
KAWASAKI Z1000	07	09	freno ant / front brake	FBC06	
KAWASAKI Z1000	10	12	freno ant / front brake	FBC19	
KAWASAKI Z1000 / SX	11	12	freno ant / front brake	FBC06	
			freno post / rear brake	FFC05	
KAWASAKI ZX10R	08	12	freno ant / front brake	FBC06	
			freno post / rear brake	FFC05	
KAWASAKI ER - 6N	06	08	freno ant / front brake	FBC02	
KAWASAKI ER-6N	09	12	freno ant / front brake	FBC16	
<b>KTM</b>					
KTM RC8 1190	08	12	freno ant / front brake	FBC06	
KTM 990 SUPER DUKE	07	12	freno ant / front brake	FBC04	
			freno post / rear brake	FFC03	
KTM 690 SM / SMR	07	12	freno ant / front brake	FFC04	
			freno post / rear brake	FFC03	
<b>MV</b>					
MV AGUSTA F4	00	09	freno ant / front brake	FBC03	
			frizione / clutch	FFC01	
MV AGUSTA BRUTALE	05	12	freno ant / front brake	FBC03	
			frizione / clutch	FFC01	
<b>SUZUKI</b>					
SUZUKI GSXR 600 / 750	04	10	freno ant / front brake	FBC06	
SUZUKI GSXR 1000	05	06	freno ant / front brake	FBC06	
SUZUKI GSXR 1000	07	08	freno ant / front brake	FBC06	
			frizione / clutch	FFC05	
SUZUKI GSXR 1000	09	12	freno ant / front brake	FBC06	
SUZUKI GSR 600	06	12	freno ant / front brake	FBC13	
SUZUKI GSR 750	11	12	freno ant / front brake	FBC13	
SUZUKI GLAGIUS 650	09	12	freno ant / front brake	FBC13	

## Coperchi pompe freno e frizione

Clutch/brake pump reservoir covers

modello - model	anno - years		codice - code		€
	dal - from	al - to			
<b>TRIUMPH</b>					
TRIUMPH STREET TRIPLE 675 / 675 R	07	12	freno post / rear brake	FFC05	
TRIUMPH DAYTONA 675 / 675 R	07	12	freno ant / front brake	FBC06	
			freno post / rear brake	FFC05	
TRIUMPH SPEED TRIPLE 1050	12	12	freno ant / front brake	FBC04	
			freno post / rear brake	FFC05	
<b>YAMAHA</b>					
YAMAHA FAZER 1000	01	05	freno ant / front brake	FBC02	
YAMAHA FZ1	06	12	freno ant / front brake	FBC11	
YAMAHA FZ6	04	06	freno ant / front brake	FBC11	
YAMAHA MT 03	06	12	freno ant / front brake	FBC11	
			freno post / rear brake	FFC05	
YAMAHA T - MAX	04	12	freno ant / front brake	FBC15	
			freno post / rear brake	FBC15	
YAMAHA R6	03	05	freno ant / front brake	FBC06	
YAMAHA R6	06	12	freno ant / front brake	FBC06	
			freno post / rear brake	FFC05	
YAMAHA R1	04	12	freno ant / front brake	FBC06	
YAMAHA XJ6	08	12	freno ant / front brake	FBC11	





# BMW R 1200 GS



**BMW R 1200 GS**

BMW R 1200 GS

**NEW**silver  
silverindaco  
indigonero  
blackColori disponibili:  
Available colours:**Riser - Riser**

codice - code	anno - years		€
	dal - from	al - to	
RIABM001	08	12	

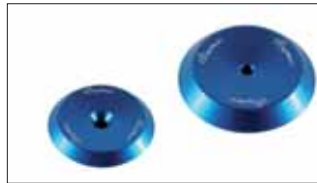
**Kit tappi telaio - Kit frame cups**

codice - code	anno - years		€
	dal - from	al - to	
CFT017	08	12	

**Coperchi pompe freno e frizione - Clutch/brake pump reservoir covers**

FBC20



FFC08

codice - code		anno - years		€
		dal - from	al - to	
FBC20	freno ant / front brake	08	12	
FFC08	frizione / clutch	08	12	

**Tappi olio - Oil filler caps**

codice - code	anno - years		€
	dal - from	al - to	
OIL 008	08	12	

**NEW**

**BMW R 1200 GS**  
BMW R 1200 GS

66



silver  
silver



indaco  
indigo



nero  
black

Colori disponibili:  
Available colours:

### Kit copricerchio - Wheel cover kit

Solo per cerchio a raggi / Only for rays wheel



codice - code	anno - years		€
	dal - from	al - to	
PMPBM103	08	12	

### Contrappesi manubrio - Handlebar balancers



codice - code	anno - years		€
	dal - from	al - to	
KTM015	08	12	

### Kit viti teste motore - Screws kit for engine head



codice - code	anno - years		€
	dal - from	al - to	
1BGH	08	12	



## Protezione telaio - Frame sliders



codice - code	anno - years		€
	dal - from	al - to	
STEBM103	08	12	

## Portatarga - License plate brackets



codice - code	anno - years		€
	dal - from	al - to	
TARBM103	08	12	

## Pedane - Rear sets



codice - code	anno - years		€
	dal - from	al - to	
FTRBM003	08	12	







**T-MAX**  
**530 / 500**



## Leve stazionamento - Parking braker levers

T-Max 530 / 500



codice - code	anno - years		€
	dal - from	al - to	
LEVD014	08	12	

## Tappi specchio - Mirror block-off plates

T-Max 530

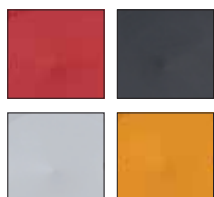

codice - code	anno - years		€
	dal - from	al - to	
SPEY08	12	12	

## Tendicinghia - Belt Adjuster

T-Max 530

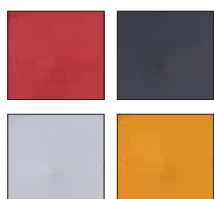

codice - code	anno - years		€
	dal - from	al - to	
TEYA001	12	12	

## Copricarter - Crankcase cover

T-Max 530 / 500



codice - code	anno - years		€
	dal - from	al - to	
STEYA002	08	12	





**Poggiapiedi - Footpeg holder**

**T-Max 530 / 500**

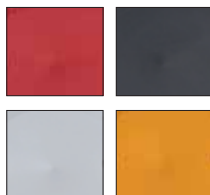

codice - code	anno - years		€ a coppia - for pair
	dal - from	al - to	
FTRYA006	08	12	

**Contrappesi manubrio New Series - Handlebar balancers New Series**

**T-Max 530 / 500**



KTM310NER



KTM310SIL



KTM310ROS

Black & White / Devil Series

codice - code	anno - years		€ a coppia - for pair
	dal - from	al - to	
KTM310	08	12	

**Contrappesi manubrio New Series - Handlebar balancers New Series**

**T-Max 530 / 500**



codice - code	anno - years		€ a coppia - for pair
	dal - from	al - to	
KTM010	08	12	

**Coperchi pompa freno - Brake pump cover**

**T-Max 530 / 500**

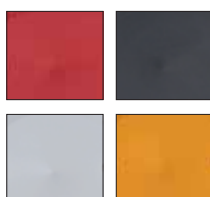

codice - code	anno - years		€ a pezzo - for piece
	dal - from	al - to	
FBC15	08	12	

## Adattatori specchio - Mirror adaptors

T-Max 530

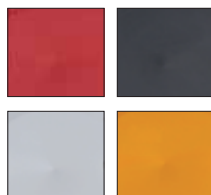

codice - code	anno - years		€ a coppia - for pair
	dal - from	al - to	
SPEY09	12	12	

## Specchio - Mirror

T-Max 530 / 500



codice - code	anno - years		€ a coppia - for pair
	dal - from	al - to	
SPEAL015NER	08	12	
fissaggio a manubrio / fixing on bar			

SPEAL019NER	12	12	
fissaggio su carena, compreso adattatore SPEY09 / fixing on fairing, included adaptor SPEY09			



codice - code	anno - years		€ a coppia - for pair
	dal - from	al - to	
SPEAL015ROS	08	12	
fissaggio a manubrio / fixing on bar			

SPEAL019ROS	12	12	
fissaggio su carena, compreso adattatore SPEY09 / fixing on fairing, included adaptor SPEY09			

## Portatarga - License plate brackets

T-Max 530



codice - code	anno - years		€ a pezzo - for piece
	dal - from	al - to	
TARYA114	12	12	
KTARYA114	12	12	





Leve - Levers

T-Max 530 / 500



codice - code	anno - years		€ a coppia - for pair
	dal - from	al - to	
KLEV035	08	12	

Parafango anteriore in carbonio - Carbon front mudguard

T-Max 530 / 500



codice - code	anno - years		€ a pezzo - for piece
	dal - from	al - to	
CARY4610	08	12	

Protezione forcellone in carbonio - Carbon swingarm protector

T-Max 530



codice - code	anno - years		€ a coppia - for pair
	dal - from	al - to	
CARY4660	12	12	

Fianchetti carena - Fairing side panels

T-Max 530



codice - code	anno - years		€ a coppia - for pair
	dal - from	al - to	
CARY4680	12	12	

Copricinghia - Belt protector

T-Max 530



codice - code	anno - years		€ a pezzo - for piece
	dal - from	al - to	
CARY4612	12	12	

## T-Max

### T-Max

#### Adattatori specchio - Mirror adaptors



#### Tappi specchio - Mirror block-off plates



#### Distanziale perno ruota - Wheel axle spacer



#### Protezione perno ruota - Wheel axle slider



#### Portatarga - License plate brackets



#### Protezione forcellone - Swingarm protector



#### Protezione forcellone - Swingarm protector



#### Tappi olio - Oil filler caps



#### Vite special 1024 - Special screw 1024



codice - code	anno - years		€
	dal - from	al - to	
SPEY06	08	11	a coppia - for pair

codice - code	anno - years		€
	dal - from	al - to	
SPEY07	08	11	a coppia - for pair

codice - code	anno - years		€
	dal - from	al - to	
DPRYA001	08	11	a pezzo - for piece

codice - code	anno - years		€
	dal - from	al - to	
STEYA003	08	11	a pezzo - for piece

codice - code	anno - years		€
	dal - from	al - to	
TARYA112	08	11	a pezzo - for piece
KTARYA112	08	11	a pezzo - for piece

codice - code	anno - years		€
	dal - from	al - to	
CARY4560	08	11	a pezzo - for piece

codice - code	anno - years		€
	dal - from	al - to	
CARY4561	08	11	a pezzo - for piece

codice - code	anno - years		€
	dal - from	al - to	
OIL004	04	12	a pezzo - for piece

codice - code	anno - years		€
	dal - from	al - to	
1024	08	12	a pezzo - for piece

**COMPONENTI  
IN CARBONIO**  
CARBON  
PARTS





## Componenti in carbonio

### Carbon parts



modello - model	codice - code	€
<b>APRILIA</b>		
<b>APRILIA RSV4 / R / FACTORY / APRC   09 - 12</b>		
parafango ant. / front mudguard	CARA3010	
parafango post. / rear mudguard	CARA3020	
coperchio frizione / clutch cover	CARA3030	
coperchio alternatore / electric cover	CARA3040	
protezioni telaio / frame protector	CARA3050	
protezioni forcellone / swingarm protector	CARA3060	
coperchio serbatoio / tank cover	CARA3029	
tubi air box	CARA3019	
copri catena / chain cover	CARA3012	
para catena inferiore / inferior chain protection	CARA3013	
fianchetti sotto serbatoio / panels under fuel tank	CARA3080	
<b>APRILIA TUONO V4   11 - 12</b>		
parafango ant. / front mudguard	CARA3010	
parafango post. / rear mudguard	CARA3020	
coperchio frizione / clutch cover	CARA3030	
coperchio alternatore / electric cover	CARA3040	
protezioni forcellone / swingarm protector	CARA3060	
coperchio serbatoio / tank cover	CARA3029	
copri catena / chain cover	CARA3012	
para catena inferiore / inferior chain protection	CARA3013	
<b>BMW</b>		
<b>BMWS 1000 RR   09 - 12</b>		
parafango ant. / front mudguard	CARB1010	
parafango post. / rear mudguard	CARB1020	
coperchio frizione / clutch cover	CARB1030	
coperchio alternatore / electric cover	CARB1040	
coperchio pick up / pick up cover	CARB1018	
protezioni telaio / frame protector	CARB1050	
protezioni forcellone / swingarm protector	CARB1060	
coperchio serbatoio / tank cover	CARB1029	
tubi airbox / racing airducts	CARB1019	





modello - model	codice - code	€
<b>DUCATI</b>		
<b>DUCATI 1199 PANIGALE   12 - 12</b>		
parafango ant. / front mudguard	CARD1010	
parafango post. / rear mudguard	CARD1020	
coperchio frizione / clutch cover	CARD1030	
coperchio alternatore / electric cover	CARD1040	
protezioni forcellone / swingarm protector	CARD1060	
copri catena / chain protector	CARD1012	
protezione corona / sprocket cover	CARD1013	
protezione monoammortizzatore / rear shock-absorber protector	CARD1039	
<b>HONDA</b>		
<b>HONDA CBR 600   03 - 04</b>		
parafango ant. / front mudguard	CARH7110	
parafango post. / rear mudguard	CARH7120	
coperchio frizione / clutch cover	CARH7130	
coperchio alternatore / electric cover	CARH7140	
protezioni telaio / frame protector	CARH7150	
protezioni forcellone / swingarm protector	CARH7160	
tubi airbox / racing airducts	CARH7119	
protezione scarico / exhaust protector	CARH7180	
<b>HONDA CBR 600   05 - 06</b>		
parafango ant. / front mudguard	CARH8910	
parafango post. / rear mudguard	CARH8920	
coperchio frizione / clutch cover	CARH8930	
coperchio alternatore / electric cover	CARH8940	
protezioni telaio / frame protector	CARH8950	
protezioni forcellone / swingarm protector	CARH8960	
tubi airbox / racing airducts	CARH8919	
protezione scarico / exhaust protector	CARH8980	
<b>HONDA CBR 600   07 - 12</b>		
parafango ant. / front mudguard	CARH6510	
parafango post. / rear mudguard	CARH8920	
coperchio frizione / clutch cover	CARH6530	
coperchio alternatore / electric cover	CARH6540	
protezioni telaio / frame protector	CARH6550	
protezioni forcellone / swingarm protector	CARH6560	
tubi airbox / racing airducts	CARH6519	
protezione scarico / exhaust protector	CARH6580	
<b>HONDA CBR 1000   04 - 07</b>		
parafango ant. / front mudguard	CARH7410	
parafango post. / rear mudguard	CARH7420	
coperchio frizione / clutch cover	CARH7430	
coperchio alternatore / electric cover	CARH7440	
protezioni telaio / frame protector	CARH7450	
protezioni forcellone / swingarm protector	CARH7414	
protezione scarico / exhaust protector	CARH7480	
copri catena / chain cover	CARH7415	
supporto strumenti / tachometer support	CARH7470	

## Componenti in carbonio

### Carbon parts



modello - model	codice - code	€
<b>HONDA CBR 1000 RR   08 - 12</b>		
parafango ant. / front mudguard	CARH7610	
parafango post. / rear mudguard	CARH7620	
coperchio alternatore / electric cover	CARH7640	
coperchio frizione / clutch cover	CARH7630	
protezioni telaio / frame protector	CARH7650	
protezioni forcellone / swingarm protector	CARH7660	
tubi air box / racing airducts	CARH7619	
supporto strumenti / tachometer support	CARH7670	
<b>HONDA CB 1000 R   08 - 12</b>		
parafango ant. / front mudguard	CARH7010	
parafango post. / rear mudguard	CARH7020	
coperchio frizione / clutch cover	CARH7030	
coperchio alternatore / electric cover	CARH7040	
copri catena / chain protector	CARH7012	
protezione corona / sprocket cover	CARH7013	
protezioni forcellone / swingarm protector	CARH7060	
frontalino copri strumenti / tachometer support cover	CARH7070	
<b>HONDA HORNET CB 600 F   11 - 12</b>		
parafango ant. / front mudguard	CARH6610	
coperchio frizione / clutch cover	CARH6630	
coperchio alternatore / electric cover	CARH6640	
<b>KAWASAKI</b>		
<b>KAWASAKI ZX6R   07 - 08</b>		
parafango ant. / front mudguard	CARK6310	
coperchio frizione / clutch cover	CARK6330	
coperchio alternatore / electric cover	CARK6340	
coperchio pick up / pick up cover	CARK6318	
protezioni telaio / frame protectors	CARK6350	
protezioni forcellone / swingarm protector	CARK6314	



modello - model	codice - code	€
<b>KAWASAKI ZX6 R   09 - 12</b>		
parafango ant. / front mudguard	CARK9510	
parafango post. / rear mudguard	CARK9520	
coperchio frizione / clutch cover	CARK9530	
coperchio alternatore / electric cover	CARK9540	
coperchio pick up / pick up cover	CARK9518	
protezioni telaio / frame protectors	CARK9550	
protezioni forcellone / swingarm protector	CARK9560	
copri catena / chain protector	CARK9512	
<b>KAWASAKI ZX10 R   06 - 07</b>		
parafango ant. / front mudguard	CARK6110	
parafango post. + copri catena / rear mudguard + chain protector	CARK6120	
coperchio frizione / clutch cover	CARK6130	
coperchio alternatore / electric cover	CARK6140	
coperchio pick up / pick up cover	CARK6118	
protezioni telaio / frame protector	CARK6150	
protezioni forcellone / swingarm protector	CARK6114	
<b>KAWASAKI ZX10 R   08 - 10</b>		
parafango ant. / front mudguard	CARK9210	
parafango post. / rear mudguard	CARK9220	
coperchio alternatore / electric cover	CARK6140	
coperchio frizione / clutch cover	CARK9230	
coperchio pick up / pick up cover	CARK6118	
protezioni telaio / frame protector	CARK9250	
protezioni forcellone / swingarm protector	CARK9260	
<b>KAWASAKI ZX10 R   11 - 12</b>		
parafango ant. / front mudguard	CARK9610	
parafango post. / rear mudguard	CARK9620	
coperchio frizione / clutch cover	CARK9630	
coperchio alternatore / electric cover	CARK9640	
coperchio pick up / pick up cover	CARK9618	
protezioni telaio / frame protector	CARK9650	
protezioni forcellone / swingarm protector	CARK9660	
<b>KAWASAKI Z750 07-12</b>		
parafango ant. / front mudguard	CARK6810	
parafango post. / rear mudguard	CARK6820	
coperchio frizione / clutch cover	CARK6830	
coperchio alternatore / electric cover	CARK6840	
coperchio pick up / pick up cover	CARK6818	

## Componenti in carbonio

### Carbon parts



modello - model	codice - code	€
<b>MV AGUSTA</b>		
F4 750 00-03 + F4 1000   04-05		
parafango ant. / front mudguard	CARM9810	
parafango post. / rear mudguard	CARM9820	
tubi air box racing / racing airducts	CARM9890	
protezioni forcellone / swingarm protector	CARM9814	
<b>SUZUKI</b>		
<b>SUZUKI GSXR 600 / 750   04 - 05</b>		
parafango ant. / front mudguard	CARS8410	
parafango post. / rear mudguard	CARS8420	
coperchio frizione / clutch cover	CARS8430	
coperchio alternatore / electric cover	CARS8440	
coperchio pick up / pick up cover	CARS8418	
protezioni telaio / frame protection	CARS8450	
tubi air box racing / racing airducts	CARS8419	
<b>SUZUKI GSXR 600 / 750   06 - 07</b>		
parafango ant. / front mudguard	CARS6010	
parafango post. / rear mudguard	CARS6020	
coperchio frizione / clutch cover	CARS6030	
coperchio alternatore / electric cover	CARS6040	
protezioni telaio / frame protection	CARS6050	
protezioni forcellone / swingarm protector	CARS6060	
tubi air box racing / racing airducts	CARS6019	
supporto strumenti / tachometer support	CARS6070	
<b>SUZUKI GSXR 600/750   08 - 10</b>		
parafango ant. / front mudguard	CARS6010	
parafango post. / rear mudguard	CARS6020	
coperchio frizione / clutch cover	CARS8030	
coperchio alternatore / electric cover	CARS6040	
protezioni telaio / frame protection	CARS6050	
protezioni forcellone / swingarm protector	CARS6060	
tubi air box racing / racing airducts	CARS8019	





modello - model	codice - code	€
<b>SUZUKI GSXR 600/750   11 - 12</b>		
parafango ant. / front mudguard	CARS6110	
parafango post. / rear mudguard	CARS6120	
coperchio frizione / clutch cover	CARS8030	
coperchio alternatore / electric cover	CARS6040	
protezioni telaio / frame protection	CARS6150	
protezioni forcellone / swingarm protector	CARS6160	
tubi air box racing / racing airducts	CARS6119	
<b>SUZUKI GSXR 1000   05 - 06</b>		
parafango ant. / front mudguard	CARS8810	
parafango post. / rear mudguard	CARS8820	
coperchio frizione / clutch cover	CARS8830	
coperchio alternatore / electric cover	CARS8840	
coperchio pick up / pick up cover	CARS8818	
coperchio pick up + starter / pick up cover + starter	CARS8817	
protezioni telaio / frame protector	CARS8850	
protezioni forcellone / swingarm protector	CARS8860	
tubi air box racing / racing airducts	CARS8819	
<b>SUZUKI GSXR 1000   07 - 08</b>		
parafango ant. / front mudguard	CARS8810	
parafango post. / rear mudguard	CARS8820	
coperchio frizione / clutch cover	CARS8830	
coperchio alternatore / electric cover	CARS8840	
coperchio motorino avviamento / starter cover	CARS8818	
coperchio pick up + starter / pick up cover + starter	CARS8817	
protezioni telaio / frame protector	CARS6750	
protezioni forcellone / swingarm protector	CARS6760	
tubi air box racing / racing airducts	CARS6719	
<b>SUZUKI GSXR 1000   09 - 12</b>		
parafango ant. / front mudguard	CARS6410	
parafango post. / rear mudguard	CARS6420	
coperchio frizione / clutch cover	CARS6430	
coperchio alternatore / electric cover	CARS6440	
protezioni telaio / frame protector	CARS6450	
protezioni forcellone / swingarm protector	CARS6460	
tubi air box racing / racing airducts	CARS6419	

## Componenti in carbonio

### Carbon parts

modello - model	codice - code	€
<b>TRIUMPH</b>		
<b>TRIUMPH DAYTONA 675 / 675R   07 - 12</b>		
parafango ant. / front mudguard	CART1010	
parafango post. / rear mudguard	CART1020	
coperchio frizione / clutch cover	CART1030	
coperchio alternatore / electric cover	CART1040	
coperchio pick up / pick up cover	CART1018	
protezioni telaio / frame protector	CART1050	
protezioni forcellone / swingarm protector	CART1060	
tubi air box racing / racing airducts	CART1019	
<b>TRIUMPH SPEED TRIPLE 1050   11 - 12</b>		
parafango ant. / front mudguard	CART1110	
parafango post. / rear mudguard	CART1120	
coperchio frizione / clutch cover	CART1130	
coperchio alternatore / electric cover	CART1140	
coperchio pick up / pick up cover	CART1118	
coperchio starter / starter cover	CART1119	
protezioni telaio / frame protector	CART1150	
protezioni forcellone / swingarm protector	CART1160	
coperchio serbatoio / tank cover	CART1129	
fianchetti serbatoio / fuel tank panels	CART1180	
fianchetti radiatore / radiator panels	CART1181	
<b>YAMAHA</b>		
<b>YAMAHA YZF R1   04 - 06</b>		
parafango ant. / front mudguard	CARY7810	
parafango post. / rear mudguard	CARY7820	
coperchio frizione 04-05 / clutch cover 04-05	CARY7830	
coperchio frizione 06 / clutch cover 06	CARY7831	
coperchio alternatore / electric cover	CARY7840	
coperchio pick up / pick up cover	CARY7818	
protezioni telaio / frame protector	CARY7850	
protezioni forcellone / swingarm protector	CARY7860	
coperchio serbatoio / tank cover	CARY7829	
tubi air box racing / racing airducts	CARY7819	
<b>YAMAHA R1   07 - 08</b>		
parafango ant. / front mudguard	CARY7810	
parafango post. / rear mudguard	CARY6620	
parafango posteriore con copri catena / rear mudguard with chain protector	CARY6621	
coperchio frizione / clutch cover	CARY6630	
coperchio alternatore / electric cover	CARY6640	
coperchio pick up / pick up cover	CARY6618	
coperchio motore lato sx / left engine cover	CARY6648	
protezioni telaio / frame protector	CARY6650	
protezioni forcellone / swingarm protector	CARY6660	
tubi air box racing / racing airducts	CARY6619	
coperchio serbatoio / tank cover	CARY6629	

modello - model	codice - code	€
<b>YAMAHA R1   09 - 12</b>		
parafango ant. / front mudguard	CARY9710	
parafango posteriore con copri catena / rear mudguard with chain protector	CARY9720	
coperchio frizione / clutch cover	CARY9730	
coperchio alternatore / electric cover	CARY9740	
protezioni telaio / frame protector	CARY9750	
protezioni forcellone / swingarm protector	CARY9760	
coperchio pick up / pick up cover	CARY9718	
tubi air box racing / racing airducts	CARY9719	
<b>YAMAHA YZF R6   03 - 05</b>		
parafango ant. / front mudguard	CARY9010	
parafango post. / rear mudguard	CARY9020	
coperchio frizione / clutch cover	CARY9030	
coperchio alternatore / electric cover	CARY9040	
coperchio pick up / pick up cover	CARY9018	
protezioni telaio / frame protector	CARY9050	
protezioni forcellone / swingarm protector	CARY9060	
tubi air box racing / racing airducts	CARY9019	
<b>YAMAHA YZF R6   06 - 12</b>		
parafango ant. / front mudguard	CARY9910	
parafango post. / rear mudguard	CARY9920	
coperchio frizione / clutch cover	CARY9930	
coperchio alternatore / electric cover	CARY9940	
coperchio pick up / pick up cover	CARY9918	
protezioni telaio / frame protection	CARY9950	
protezioni forcellone / swingarm protector	CARY9960	
tubi air box racing + supp. strumenti / racing airducts + tachometer support (06-07)	CARY9919	
tubi air box racing + supp. strumenti / racing airducts + tachometer support (08-11)	CARY9819	
<b>YAMAHA FZ1   06 - 11</b>		
parafango ant. / front mudguard	CARY4010	
parafango post. / rear mudguard	CARY4020	
coperchio frizione / clutch cover	CARY4030	
coperchio alternatore / electric cover	CARY4040	
coperchio pick up / pick up cover	CARY4018	
copri catena/ chain cover	CARY4012	
<b>YAMAHA T-MAX   08 - 11</b>		
parafango ant. / front mudguard	CARY4610	
protezioni forcellone aperto / swingarm protector open	CARY4560	
protezioni forcellone chiuso / swingarm protector close	CARY4561	
<b>YAMAHA T-MAX   12 - 12</b>		
parafango ant. / front mudguard	CARY4610	
copri forcellone / swingarm protector	CARY4660	
copri cinghia / belt protector	CARY4612	
fianchetti laterali sottosella / fairing side panels	CARY4680	
<b>PINNA PROTEZIONE CATENA / CHAIN PROTECTION</b>		
	CAR001	







**CAVALLETTI  
STANDS**

**RACING & BOX**





MODULAR

modello - model	codice - code	€
Cavalletto componibile posteriore in ferro a 4 ruote Modular iron rear stand with 4 wheels	RSF038	



MODULAR

modello - model	codice - code	€
Cavalletto componibile posteriore in ferro a 4 ruote con forchette Modular iron rear stand with 4 wheels and forks	 RSF039F	
Cavalletto componibile posteriore in ferro a 4 ruote con pattini Modular iron rear stand with 4 wheels and sliding blocks	 RSF039P	
Cavalletto componibile posteriore in ferro a 4 ruote con rulli Modular iron rear stand with 4 wheels and rollers	 RSF039R	





modello - model	codice - code	€
Cavalletto posteriore in ferro a 2 ruote con forchette Iron rear stand with 2 wheels and forks	RSF036	



modello - model	codice - code	€
Cavalletto posteriore in ferro a 2 ruote con forchette Iron rear stand with 2 wheels and forks	 RSF037F	
Cavalletto posteriore in ferro a 2 ruote con pattini Iron rear stand with 2 wheels and sliding blocks	 RSF037P	
Cavalletto posteriore in ferro a 2 ruote rulli Iron rear stand with 2 wheels and rollers	 RSF037R	

## Ricambi per cavalletti

## Stands spare parts

## Forchette - Forks



codice - code	a coppia - for pair
RSF23	

## Pattini - Sliding blocks



codice - code	a coppia - for pair
RSF24	

## Rulli - Rollers



codice - code	a coppia - for pair
RSF25	

## Ruote - Wheels



codice - code	a coppia - for pair
RW001	

## Cavalletti

## Stands



modello - model	codice - code	€
Cavalletto anteriore in ferro Iron front stand	RSF22	



modello - model	codice - code	€
Cavalletto posteriore in ferro con forchette Iron rear stand with forks	RSF21	
Cavalletto posteriore in ferro con pattini Iron rear stand with sliding blocks	RSF21P	
Cavalletto posteriore in ferro con rulli Iron rear stand with rollers	RSF21R	



Cavalletto posteriore monobraccio in ferro  
Iron one armed rear stand

modello - model	∅	codice - code	€
BMW R 1200 GS	53,5	RSF011	
DUCATI 848 -848 EVO - 748	25,7	RSF005	
<b>NEW</b> DUCATI 1098+1198	40,6	RSF004	
DUCATI 1199 panigale	40,6	RSF004	
DUCATI 996 - 998	25,7	RSF005	
DUCATI S2R - S4R	25,7	RSF005	
DUCATI MONSTER	25,7	RSF005	
DUCATI MULTISTRADA 1100	25,7	RSF005	
<b>NEW</b> DUCATI MULTISTRADA 1200	40,6	RSF004	
DUCATI HYPERMOTARD 796 + 1100	25,7	RSF005	
DUCATI STREETFIGHTER 848 + 1100	25,7	RSF005	
DUCATI DIAVEL	40,6	RSF004	
HONDA CB 1000 R	28,4	RSF002	
HONDA VFR 800	28,4	RSF002	
<b>NEW</b> MV BRUTALE	42,7	RSF001	
MV F4 + F3	42,7	RSF001	
TRIUMPH SPEED TRIPLE 1050	26,8	RSF003	



Perno per cavalletto monobraccio in ferro  
Pin for iron one armed rear stand

∅ perno - ∅ pin	codice - code	€
42,7	RSF26	
28,4	RSF27	
26,8	RSF28	
40,6	RSF29	
25,7	RSF30	
53,5	RSF37	





modello - model	codice - code	€
Coppia cavalletti sfilabili h 380 / 560 in alluminio Pair of aluminium extensible stands h 380 / 560	RSA002	



modello - model	codice - code	€
Coppia cavalletti sfilabili h 670 / 940 in alluminio Pair of aluminium extensible stands h 670 / 940	RSA003	



modello - model	codice - code	€
Cavalletto anteriore centrale in ferro Iron front triple tree lift	RSF035	



modello - model	codice - code	€
Cavalletto anteriore in ferro Iron front stand	RSF008	

## Accessori box

### Box accessories



modello - model	codice - code	€
Carrello porta cerchi in alluminio Aluminium rims carrier	RSA13	



modello - model	codice - code	€
Rastrelliera porta cerchi in alluminio con 10 postazioni Aluminium rims rack with 10 positions	RSA14	



modello - model	codice - code	€
Banco portamoto in carbonio 2100mm x 650mm Carbon bench table 2100mm x 650mm	RSA001	



modello - model	codice - code	€
Seggiolino officina in ferro Iron workshop stool	RSF20	



modello - model	codice - code	€
Carrello pit-lane in alluminio Aluminium pit-lane trolley	RSA004	

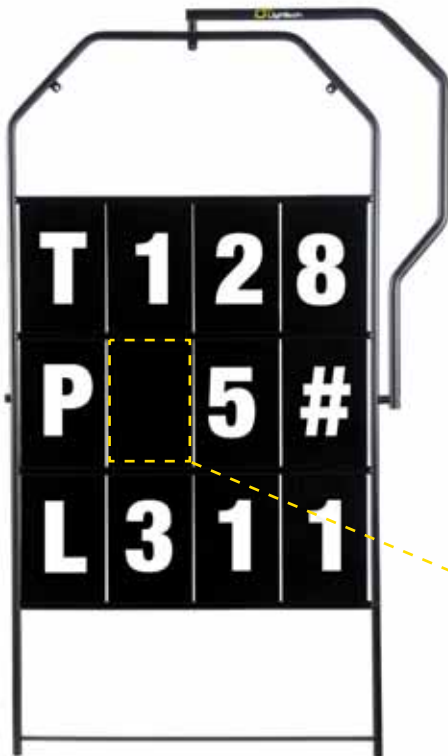

modello - model	codice - code	€
Pitboard in acciaio inox Stainless steel pitboard	TTG001	

completa di 50 tabelle senza lettere e cifre  
with 50 tables without letters and numbers



## Saponette

Knee sliders



Andrea Dovizioso  
Cal Crutchlow



articolo - article	codice - code	€
		a coppia - for pair
Rain	SAPR001	
Colori disponibili: rosso / Available colours: red		
	Ricambio / Spare part	RSAPR001



articolo - article	codice - code	€
		a coppia - for pair
Filler	SAPF	
Colori disponibili: rosso, blu, bianco, nero, giallo Available colours: red, blue, white, yellow, black		



articolo - article	codice - code	€
		a coppia - for pair
Nuke	SAPN	
Colori disponibili: nero Available colours: black		



## Saponette

Knee sliders



articolo - article	codice - code	€
		a coppia - for pair
Dropper	SAPDRO	

Colori disponibili: rosso, blu, bianco, nero, giallo  
Available colours: red, blue, white, yellow, black



articolo - article	codice - code	€
		a coppia - for pair
Leather	SAPL	

Cuoio - Leather



articolo - article	codice - code	€
		a coppia - for pair
Fire titan nuke	SAPT	

nuke con inserti in titanio - Nuk with titanium

## Neoprene per sella

Neoprene for racing seat



articolo - article	codice - code	€
mm 330 x 330 x 15	NSR01	

## Serbatoio rifornimento rapido

Fast fuel canister

NEW



Colori disponibili: rosso, oro, nero.  
Available colours: red, gold, black.



con foro centrato - with central hole



modello - model	codice - code	colore serbatoio fuel canister colour	€
5 LITRI / litres	SER01	inox	
10 LITRI / litres	SER02	inox	



con foro decentrato - with not central hole

modello - model	codice - code	colore serbatoio fuel canister colour	€
5 LITRI / litres	SER04	inox	
10 LITRI / litres	SER05	inox	



**RACCORDERIA  
FRENO  
BRAKE PARTS**

LightTech

## Raccorderia freno

### Brake parts



modello - model	misura - measure	codice - code	€
Bullone singolo Single banjo bolt	M 10 X 1	VF11	
	M 10 X 1,25	VF1251	



modello - model	misura - measure	codice - code	€
Bullone doppio Double banjo bolt	M 10 X 1	VF12	
	M 10 X 1,25	VF1252	



modello - model	misura - measure	codice - code	€
Bullone singolo con spurgo Single banjo bolt with bleeder	M 10 X 1	VF11SP	
	M 10 X 1,25	VF1251SP	



modello - model	misura - measure	codice - code	€
Bullone doppio con spurgo Double banjo bolt with bleeder	M 10 X 1	VF12SP	
	M 10 X 1,25	VF1252SP	



modello - model	codice - code	€
Ogiva ottone Brass hose holder	OG	



modello - model	codice - code	€
Raccordo tre vie completo di ogiva e dadi Three-way joint set with hose holders and nuts	RAC3	



modello - model	codice - code	€
Rondelle alluminio Aluminium washers	RONA	



modello - model	codice - code	€
Tubo maglia d'acciaio Hose steel covered	TUBT	



modello - model	codice - code	€
Occhiello dritto con dado Bajo fitting set	OCD	





modello - model	codice - code	€
Occhiello 25° con dado 25° elbow banjo fitting set	OC25	



modello - model	codice - code	€
Occhiello 45° con dado 45° elbow banjo fitting set	OC45	



modello - model	codice - code	€
Occhiello 90° con dado 90° elbow banjo fitting set	OC90	



modello - model	misura - measure	codice - code	€
Spurgo Bleeder	M6	SPM6	
	M7	SPM7	
	M8	SPM8	
	M 10 x 1	SPM10	



modello - model	codice - code	€
Dado per occhielli Banjo nut	DAD	



modello - model	codice - code	€
Guaina termoretraibile Thermoshrinking	GUAINA	
Disponibile nei colori: blu, rosso, giallo, trasparente, nero Available cours: blue, red, gold, transparent, black		



modello - model	codice - code	€
Spiralina nera Black- spiral thermoshrinking	SPI	



modello - model	codice - code	€
Raccorderia freno, guaina, tubo in treccia Brake screws, thermo shrinking, hose	KIT SKB	



modello - model	codice - code	€
Espositore da terra - 65x200 cm Floor display stand - 65x200 cm	EXP001	



modello - model	codice - code	€
Espositore da terra - 65x200 cm Floor display stand - 65x200 cm	GRITE	



modello - model	codice - code	€
Espositore da banco - 28x42 cm Table display stand - 28x42 cm	EXP003	

APRILIA RSV4



KTARAP102



STEAP102



STEAP104



OIL002



TEAP001



FTRAP001LTD



TF10



KIT - KLEV021J



SPE111





BMW S1000RR



KTARBM101



STEBM101



CARB1010



CARB1040



TEBM101IND



TF11IND



RSF21



CAVM8IND



SPEC4



DUCATI DIAVEL



FTRDU003WROS



FTRDU003WNER



KTM301SIL

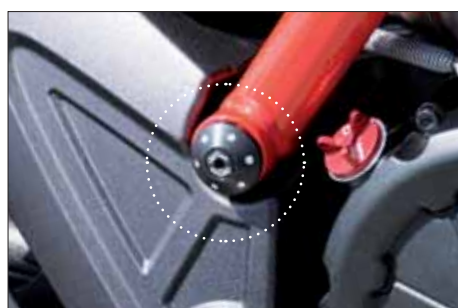

CFT\_\_NER



OIL003ROS



(right) FBC21ROS

(left) FFC09ROS



TF13NER



KLEV022J



ARDU101ROS



## DUCATI PANIGALE



CARD1039



KTM318ROS



FTRDU006W



KTARDU109ROS



CARD1030



KIT - KLEV022J



SPE113NER



ARDU101ROS



TF12NER



**DUCATI STREETFIGHTER**



TR10ROS



FBC18ROS

FFC07ROS



SPEAL014DNER



FTRDU002W



KTARDU106



KIT - KLEV022J



RSF005



STEDU103



FRE02NER

# Photo Gallery

## Photo Gallery

### HONDA CB1000R



OILHWBLU



TF2BLU



KTM006BLU



D023BLU



KTARH0107



CARH7070



D006BLU



CARH7060

CARH7013



FBC06BLU

FFC05BLU



**TRIUMPH SPEED TRIPLE**



FBC04ORO



TR14ORO



KTM300ORO



D020ORO



KTARTR105



FTRTR003



CART1110



STETR104



KIT - KLEV038J

## Condizioni generali di vendita

### PREZZI

I prezzi esposti nel catalogo sono espressi in euro, IVA esclusa.

### TRASPORTO

Il trasporto avverrà tramite corriere e le spese di trasporto verranno evidenziate e addebitate in fattura.

### TEMPI E MODALITÀ DI CONSEGNA

La consegna dei prodotti viene normalmente assicurata entro 15 giorni dal ricevimento dell'ordine. I prodotti Lightech® possono essere consegnati in tutto il mondo.

### RESO MERCE

Nell'eventualità che il cliente riceva un prodotto che presenta delle difettosità o anomalie rispetto a quanto ordinato, dovrà entro 5 giorni lavorativi dalla ricezione della consegna informare il Servizio Clienti Lightech a mezzo fax oppure via e-mail (sales@lightech.it), per ricevere le istruzioni circa la restituzione del prodotto difettoso.

### IMPORTO ORDINE MINIMO

L'importo minimo per ogni ordine è di € 60,00 al netto di sconti, tasse e spese di trasporto.

### PAGAMENTO

Per ordini inferiori ai € 100,00, il pagamento della merce avverrà in contassegno e oltre alle spese di trasporto verranno addebitate anche le spese di incasso.

### MARCHI

I seguenti marchi registrati con i nomi: Aprilia®, Ducati®, Honda®, Kawasaki®, Mv Agusta®, Suzuki®, Triumph®, Yamaha® sono di proprietà delle rispettive Case e vengono qui utilizzati a solo titolo descrittivo.

### VARIAZIONI AL CATALOGO

Lightech srl, si riserva la facoltà di apportare variazioni sia al presente catalogo che alle presenti condizioni di vendita, in qualsiasi momento e senza preavviso.

Lightech srl si riserva il diritto di apportare modifiche costruttive sui prodotti. Salvo errori ed omissioni. Questo catalogo fornisce informazioni di carattere generale e non costituisce documento contrattuale.

### AVVERTENZE

I prodotti Lightech® sono stati progettati e realizzati per l'utilizzazione in ambiti agonistici. Lightech® non si assume pertanto alcuna responsabilità per un eventuale uso non corretto dei propri prodotti.

### INFORMAZIONE SUI PRODOTTI

Tutti gli articoli inseriti nel catalogo vengono prodotti in Italia presso gli stabilimenti della Lightech srl. Le fotografie, le informazioni e le schede tecniche che illustrano i prodotti e le caratteristiche tecniche, sono di proprietà esclusiva della Lightech srl.

### CONTROVERSIE E RESPONSABILITÀ

Queste Condizioni Generali sono regolate dalle Leggi Italiane. Per qualsiasi controversia relativa alla validità, interpretazione o esecuzione delle medesime, la competenza territoriale è quella di Treviso.

**Colori disponibili: rosso, blu, oro, nero, silver, indaco, ad eccezione di dove diversamente indicato.**

## Sales conditions prices

### PRICE

The prices on catalogue are done in euro. VAT not included.

### TRANSPORT

By express courier with transport charges on your account in invoice.

### DELIVERY TIMES AND WAY

Normally our delivery times are 15 days from the receiving of the order. Lightech® products can be delivered all over the world.

### RETURNS

We accept claims within 5 days from the receiving of the goods. Returns will be accepted only if authorized by Lightech srl. So you have to inform us by fax, by e-mail (sales@lightech.it) or by phone giving us details about the goods ordered, invoice number and reasons for the returning of them.

### PAYMENT

On your choice between:  
PRO-FORMA INVOICE, to pay by advanced bank transfer or Credit Card;  
CASH ON DELIVERY, with bank charges on invoice.

### TRADEMARK

Aprilia®, Ducati®, Honda®, Kawasaki®, Mv Agusta®, Suzuki®, Triumph®, Yamaha® are registered trademarks, here used only as a reference.

### CHANGES

Lightech will be able to change the prices and sales conditions of this catalogue at any moment also without notice for commercial and technical reasons.

Lightech reserves the right to make design and technical changes on products.

Errors and omissions excepted.

This catalog provides information of a general nature and it is not contractually binding.

### NOTICE

All Lightech® products are designed and realized only for agonistic use and in a closed circuit.

### INFORMATION ABOUT PRODUCTS

All articles on this catalogue are made in Italy. We produce all in our company in Santa Lucia di Piave (TV). The photos and the informations present in the catalogue are Lightech srl property. All rights reserved.

### LEGISLATION

This contract shall come under Italian laws.

The territorial jurisdiction is Treviso.

**Colours available: red, light blue, gold, black, silver, dark blue, except where other colours are indicated.**





Lightech srl  
Via Serenissima, 15  
31025 S. Lucia di Piave (TV)

Tel. +39 0438 453010  
Fax +39 0438 655919

info@lightech.it  
www.lightech.it



seguici su  
Lightech Racing



seguici su  
LighTech\_Racing

USA & Canada  
Distributor:

